





# CATALOGUE SUPPLEMENT #2

MASSIMO TONETTO HEAD OF DESIGN VENICEM

LIGHTING

---

FURNITURE

---

TECHNICAL DATA

---

I	N	D	E	X	3				
ALMOST		ESSENCE		WALL	4				
ESSENCE				WALL	6				
GLAM				TABLE	10				
GLAM				WALL	12				
GRACE				SUSPENSION	14				
LESS				SYSTEM	16				
MISTY				SUSPENSION	22				
MISTY				TABLE	24				
MONDRIAN	GLASS			CEILING	26				
NUMA				FLOOR	28				
NUMA				WALL	30				
P	I	N	O	C	C	H	I	O	32
RECTUS								TABLE	34
RECTUS								FLOOR	34
SPEAR								CHANDELIER	36
VCM								SYSTEM	40
URBAN	LIGHTLINE							SUSPENSION	42
URBAN		LIGHTLINE						WALL	44

46

56

# ALMOST ESSENCE WALL

MATTE BLACK NICKEL + PEWTER P.57





DELABRÉ<sup>®</sup> BRASS + PEWTER P.57

# ESSENCE WALL

DELABRÉ COPPER + ANTIQUE COPPER P.57







DELABRÉ BRASS + ANTIQUE COPPER P.57





MATTE BLACK NICKEL + PEWTER P.57



# GLAM TABLE

PEWTER + DELABRÉ BRASS P.58





BURNISHED NATURAL BRASS + DARK BURNISHED BRASS P.58



# GLAM WALL

PEWTER + DELABRÉ BRASS P.58





BURNISHED NATURAL BRASS + DARK BURNISHED BRASS P.58



# GRACE SUSPENSION



GRACE COMPOSITION P.60





GRACE 50 P.59



# LESS SYSTEM





BURNISHED NATURAL BRASS P.61





BURNISHED NATURAL BRASS P.61







POLISHED BLACK NICKEL P.61



# MISTY SUSPENSION

BURNISHED NATURAL BRASS P.62







# MISTY TABLE

BURNISHED NATURAL BRASS P.62





# MONDRIAN GLASS CEILING

MATTE BLACK NICKEL P.63





# NUMA FLOOR

DARK BURNISHED BRASS P.64

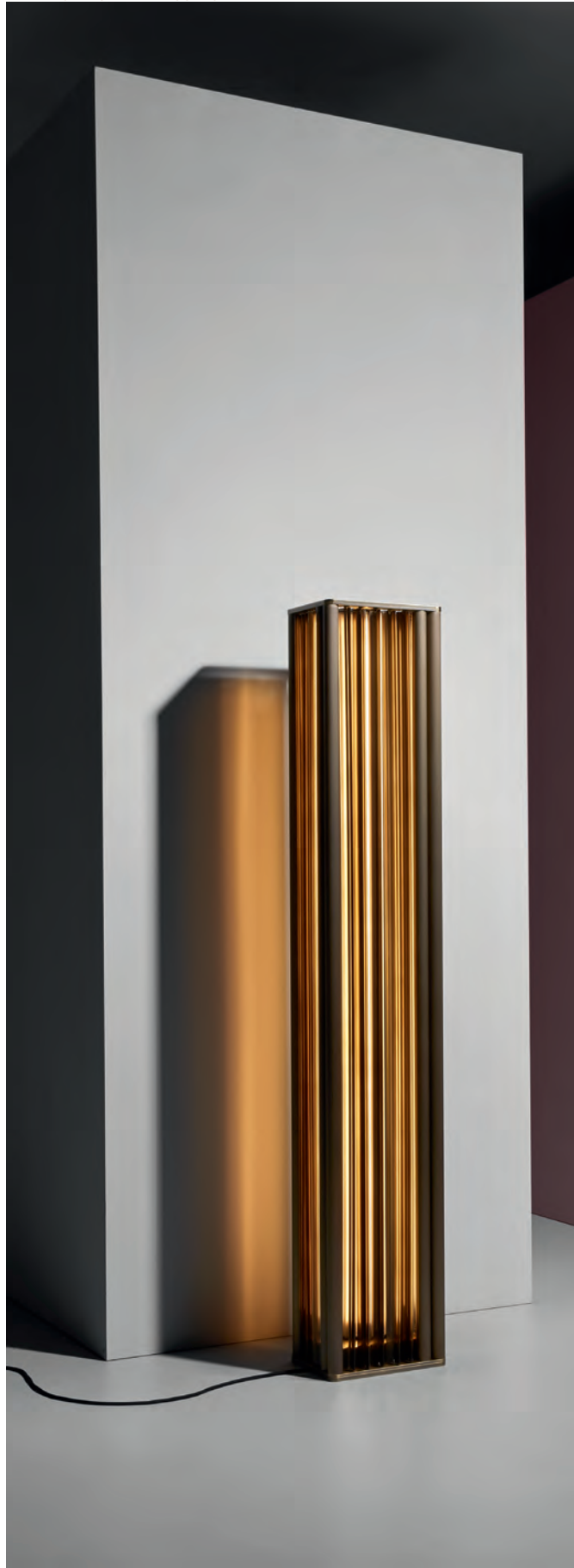
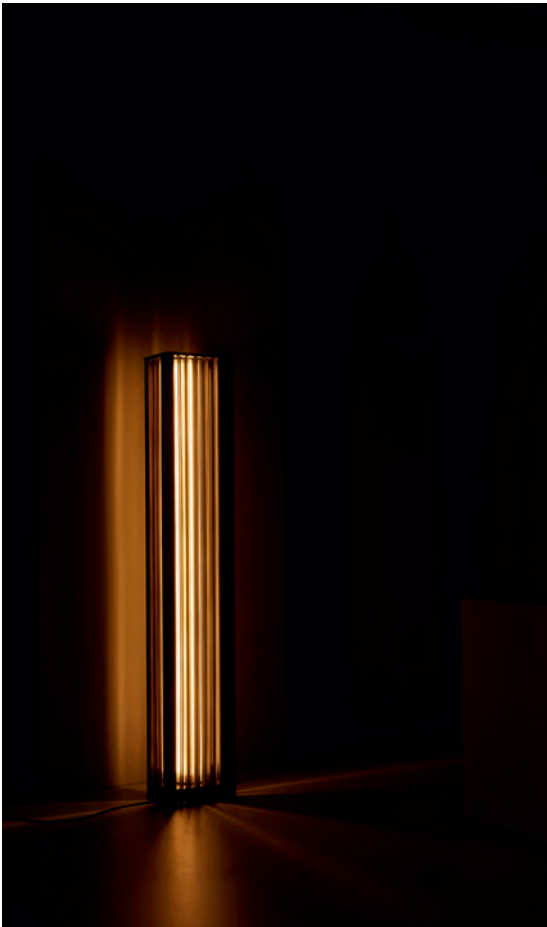

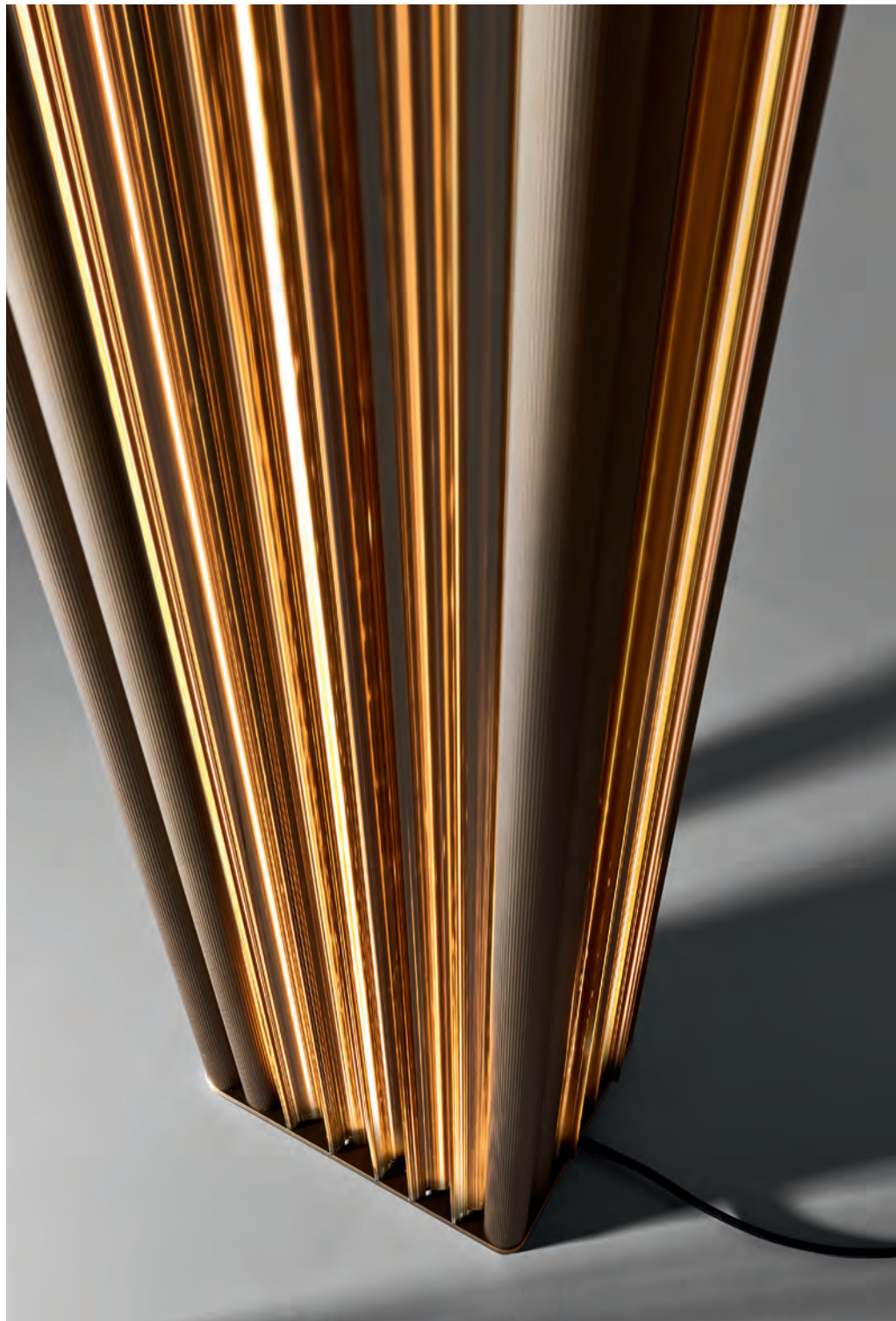
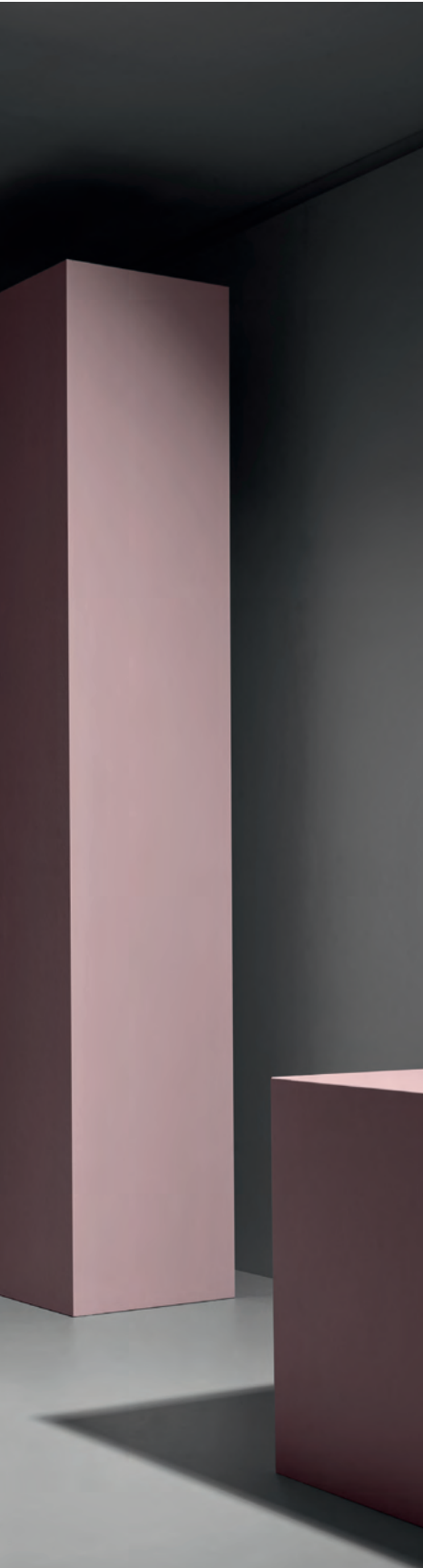

# NUMA WALL





DARK BURNISHED BRASS P.64

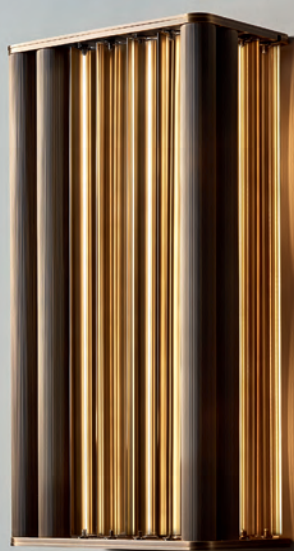

# PINOCCHIO

MATTE BLACK NICKEL + POLISHED BLACK NICKEL P.65



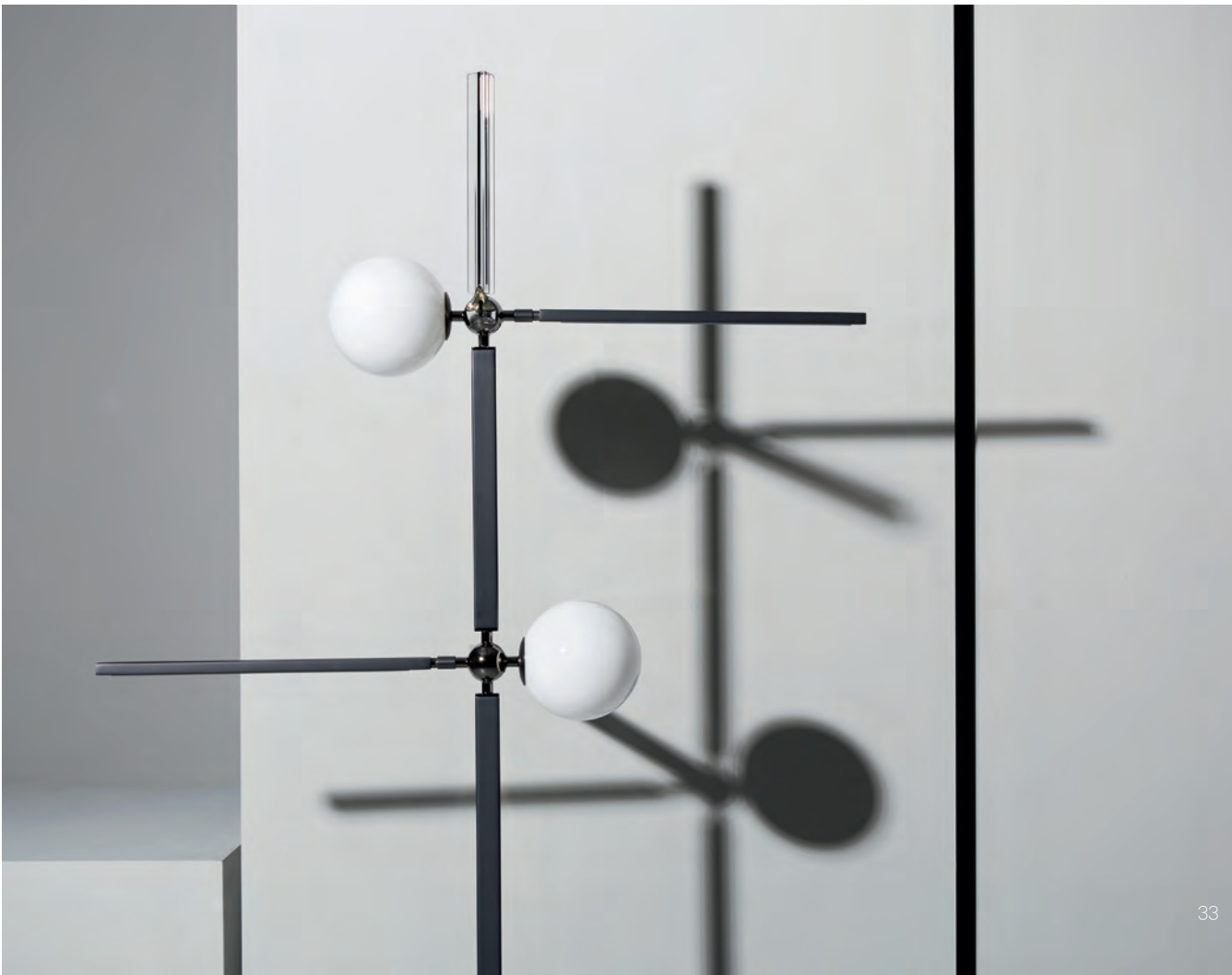

# RECTUS FLOOR & TABLE

RECTUS FLOOR P.66



RECTUS TABLE P.66



# SPEAR CHANDELIER

POLISHED BLACK NICKEL P.67











LIGHT BURNISHED BRASS P.67



# VCM SYSTEM





DARK BURNISHED BRASS P.69



# URBAN LIGHTLINE SUSPENSION

LIGHT BURNISHED BRASS + MATTE BLACK P.68





# URBAN LIGHTLINE WALL

LIGHT BURNISHED BRASS + MATTE BLACK P.68



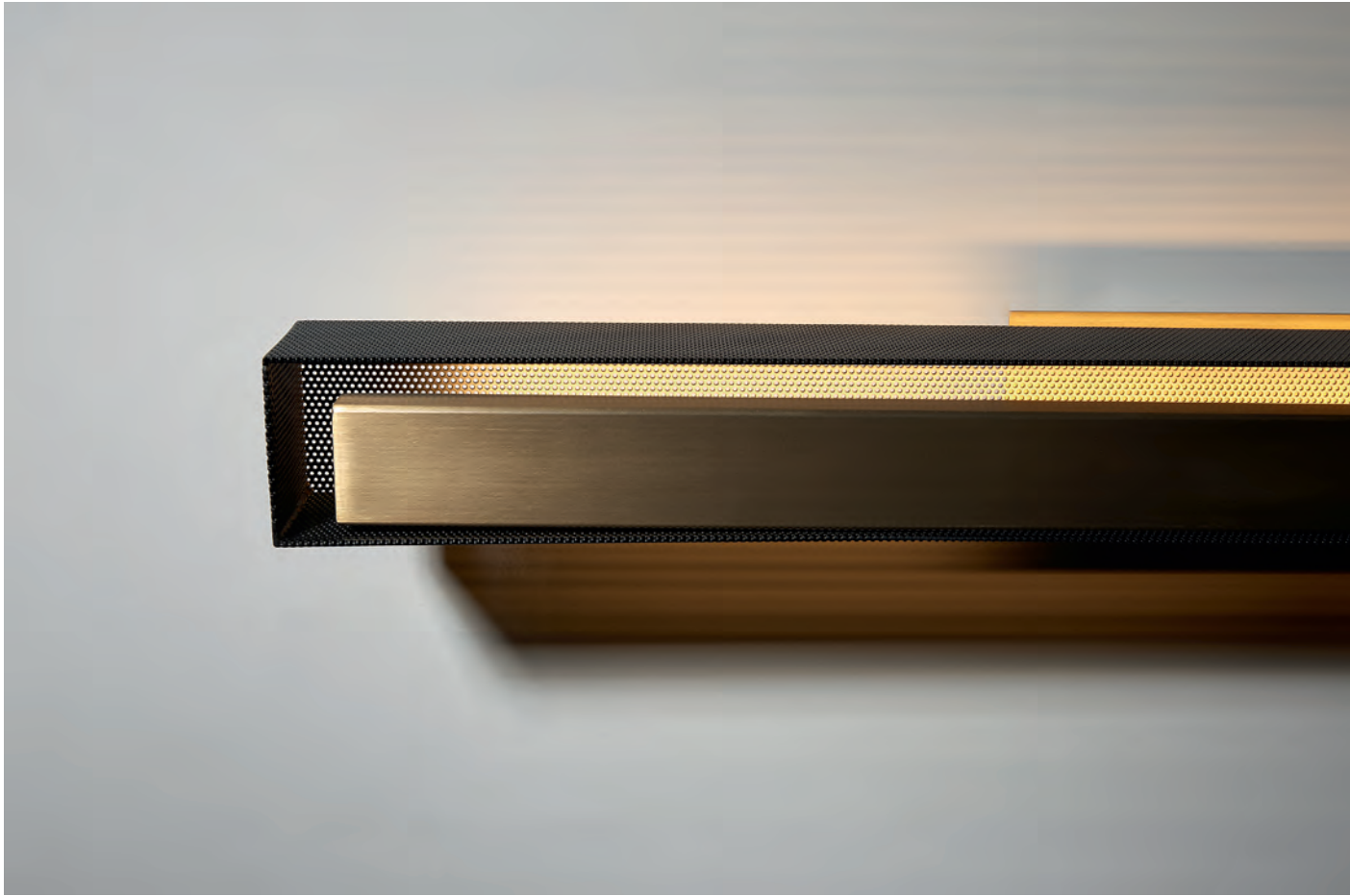





I	N	D	E	X	46
EQUILIBRE		COFFEE		TABLE	48
SERGE				CABINET	50
URBAN		COFFEE		TABLE	52
WAVE		COFFEE		TABLE	54

# EQUILIBRE COFFEE TABLE

DELABRÉ BRASS | DELABRÉ COPPER P.70



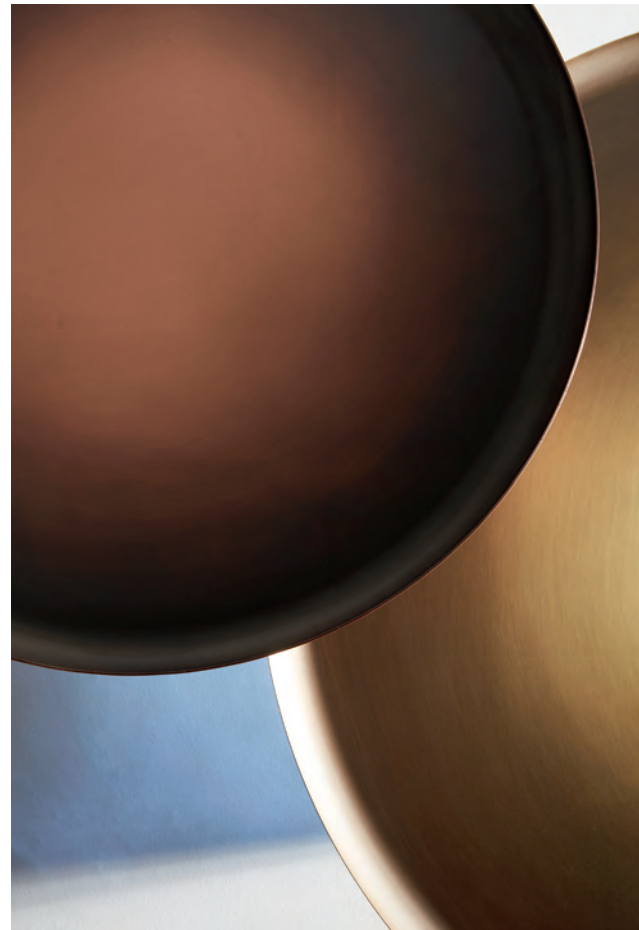

# SERGE CABINET

DARK BRONZE STRIPED + BRONZE ANTIQUE MIRROR P.70





# URBAN COFFEE TABLE

LIGHT BURNISHED BRASS + MATTE BLACK P.71



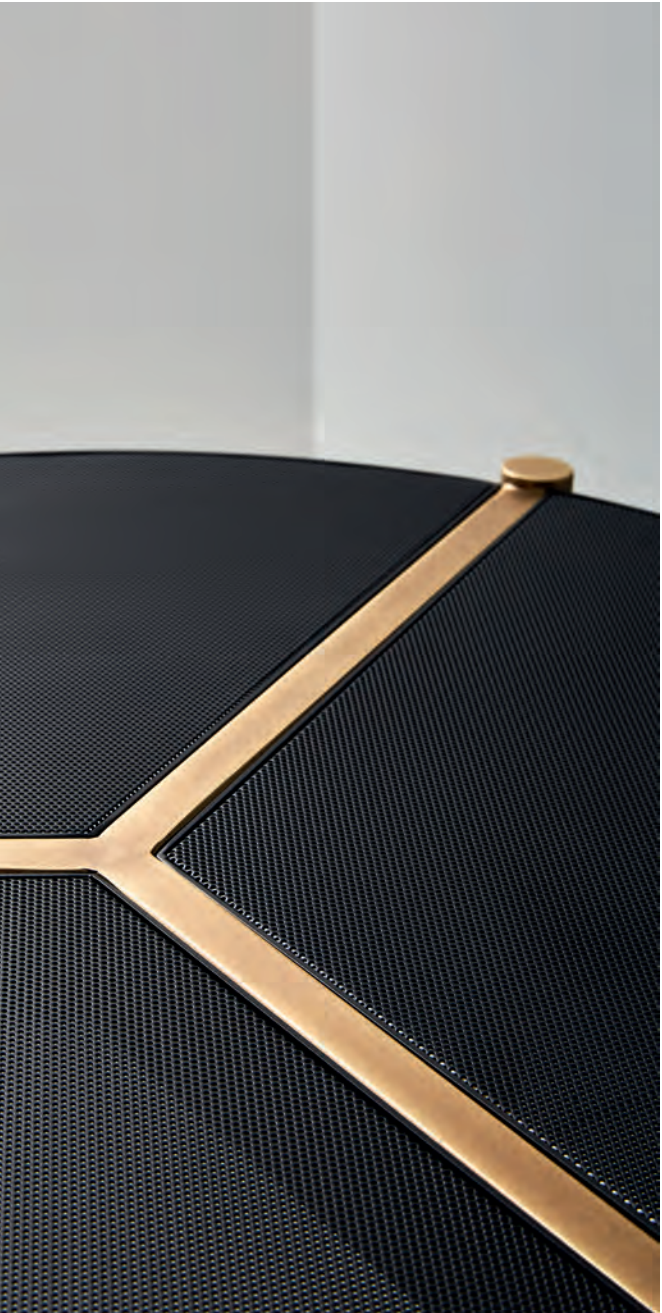

WAVE COFFEE TABLE







LIGHT BURNISHED BRASS + SMOKE GREYA P.71





## ALMOST ESSENCE WALL

Wall lamp with diffused light. Delabré brass, delabré copper or matt black nickel structure. Pewter, antique copper or matte black nickel plate.

Lampada da parete a luce diffusa. Struttura in ottone delabré, nichel nero opaco o rame delabré. Piastra in peltro, verderame o nichel nero opaco.

## LIGHTING

P. 4

Strip LED 13W 24V 1330lm 2700°K CRI 80 Dimmable

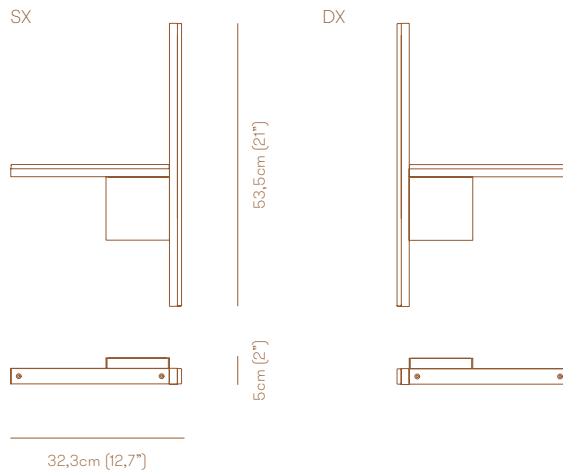

## ESSENCE WALL

Wall lamp with diffused light. Delabré brass, delabré copper or matt black nickel structure. Pewter, antique copper or matte black nickel plate.

Lampada da parete a luce diffusa. Struttura in ottone delabré, nichel nero opaco o rame delabré. Piastra in peltro, verderame o nichel nero opaco.

## LIGHTING

P. 6

Strip LED 20W 24V 2150lm 2700°K CRI 80 Dimmable

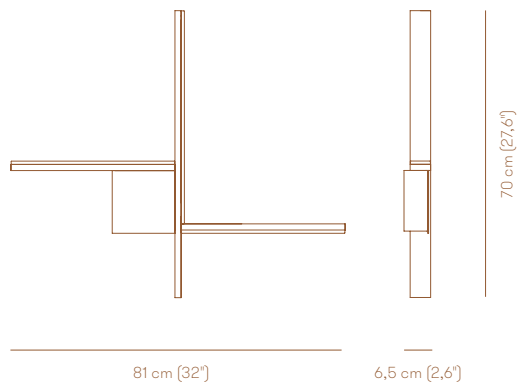

## GLAM TABLE

Table lamp with diffused light. Pewter combined with delabr  brass or burnished natural brass combined with dark burnished brass structure. White glass diffuser.

Lampada da tavolo a luce diffusa. Struttura in peltro abbinato all'ottone delabr  o in ottone brunito scuro abbinato al brunito naturale. Diffusore in vetro bianco.

## LIGHTING

P. 10

Plate 36 LED 500mA 18V 9W 2700 K 900lm Dimmable

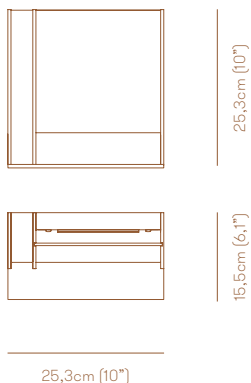

## GLAM WALL

Wall lamp with diffused light. Pewter combined with delabr  brass or burnished natural brass combined with dark burnished brass structure. White glass diffuser.

Lampada da parete a luce diffusa. Struttura in peltro abbinato all'ottone delabr  o in ottone brunito scuro abbinato al brunito naturale. Diffusore in vetro bianco.

## LIGHTING

P. 12

Plate 36 LED 500mA 18V 9W 2700 K 900lm Dimmable

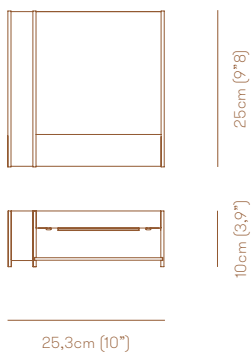

## GRACE SUSPENSION 40

Suspended lamp with diffused light. Matte black metal structure with steel cables, composed of crystal triangular trihedrons. Strip LED inside the central cylindrical body. Cables adjustable in height.

Lampada a sospensione a luce diffusa. Struttura in metallo color nero opaco sospesa con cavi d'acciaio e composta da triedri cristallo di sezione triangolare. Strip LED inserita nel corpo cilindrico centrale. Cavi regolabili in altezza.

## LIGHTING

1x12W LED 1590lm 2700°K CRI90 Dimmable 0-10V.

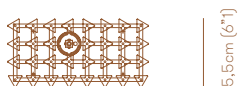
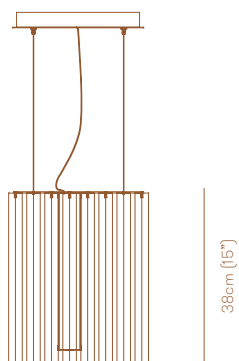

31cm (12\"/>

## GRACE SUSPENSION 50

Suspended lamp with diffused light. Matte black metal structure with steel cables, composed of crystal triangular trihedrons. Strip LED inside the central cylindrical body. Cables adjustable in height.

Lampada a sospensione a luce diffusa. Struttura in metallo color nero opaco sospesa con cavi d'acciaio e composta da triedri cristallo di sezione triangolare. Strip LED inserita nel corpo cilindrico centrale. Cavi regolabili in altezza.

## LIGHTING

P. 14

1x17W LED 2225lm 2700°K CRI90 Dimmable 0-10V.

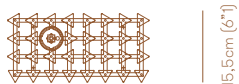
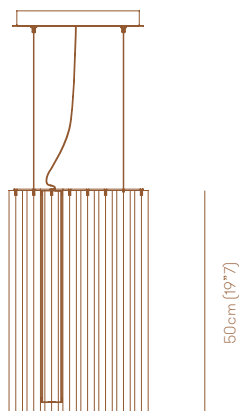

31cm (12\"/>

## GRACE COMPOSITION

Suspended lamp with diffused light.  
Matte black metal structure with  
steel cables, composed of crystal  
triangular trihedrons. Strip LED inside  
the central cylindrical body. Cables  
adjustable in height.

Lampada a sospensione a luce  
diffusa. Struttura in metallo color  
nero opaco sospesa con cavi  
d'acciaio e composta da triedri  
cristallo di sezione triangolare.  
Strip LED inserita nel corpo cilindrico  
centrale. Cavi regolabili in altezza.

## LIGHTING

P. 14

1x12W LED 1590lm 2700°K CRI90

+ 2x17W LED 2225lm 2700°K CRI90 Dimm. 0-10V.

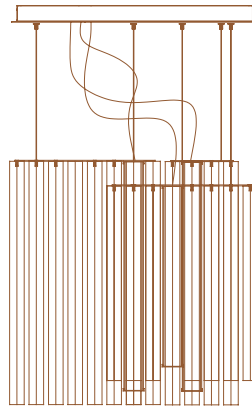

60cm (23"6)

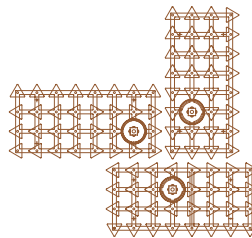

47,5cm (18"7)

51,5cm (20"3)

Suspended lamp with diffused light. Burnished natural brass, polished black nickel or matte black nickel structure composed of brass profiles, satin blown glass spheres and satin glass diffusers. Self-supporting black fabric cords and steel cables with rapid fixing system.

Lampada a sospensione con luce diffusa. Struttura in ottone naturale brunito, nichel nero lucido o nichel nero opaco composta da profili in ottone, sfere in vetro soffiato satinato e diffusori in vetro satinato. Cavo autoportante in tessuto nero e cavi di acciaio con sistema di fissaggio rapido.

1x5W G9 LED 350lm 2700°K Dimm.

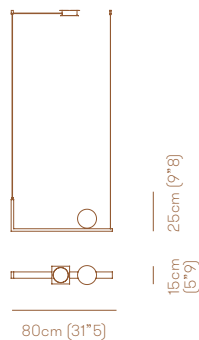

1x5W G9 LED 350lm 2700°K Dimm.

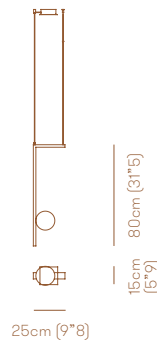

1x12W strip LED 24V 1250lm 2700°K Dimm.

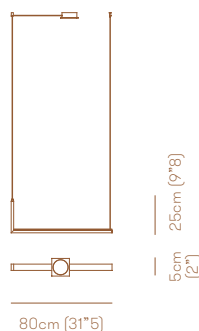

1x12W strip LED 24V 1250lm 2700°K Dimm.

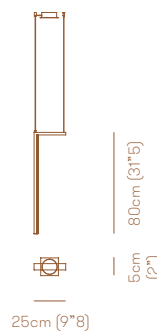

2x12W strip LED 24V 1250lm 2700°K Dimm.

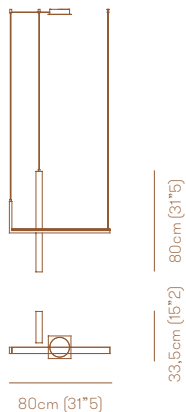

2x5W G9 LED 350lm 2700°K Dimm.

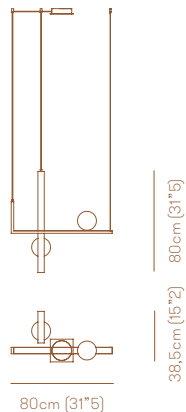

1x12W strip LED 24V 1250lm 2700°K Dimm.  
+ 1x5W G9 LED 350lm 2700°K Dimm.

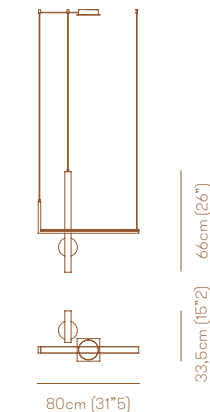

3x12W strip LED 24V 1250lm 2700°K Dimm.  
+ 2x5W G9 LED 350lm 2700°K Dimm.

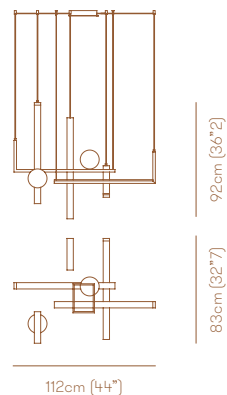

1x12W strip LED 24V 1250lm 2700°K Dimm.  
+ 2x5W G9 LED 350lm 2700°K Dimm.

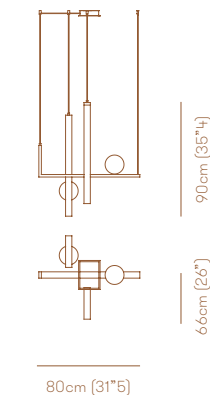

## MISTY TABLE

Table lamp with diffused light. Natural burnished brass structure and white blending blown glass diffuser.

Lampada da tavolo a luce diffusa. Struttura in ottone naturale brunito e diffusore in vetro soffiato bianco sfumato.

## LIGHTING

P. 24

1x9W LED 18V 880lm 2700° K CRI90 Dimmable with touch dimmer

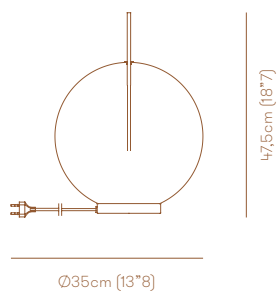

## MISTY SUSPENSION

Suspended lamp with diffused light. Natural burnished brass structure. White blending blown glass diffuser.

Lampada a sospensione a luce diffusa. Struttura in ottone naturale brunito. Diffusore in vetro soffiato bianco sfumato.

## LIGHTING

P. 22

Ø 45: 1x16,6W LED 24V 2025lm 2700° K CRI80 Dimmable 0-10V

Ø 35: 1x12W LED 24V 1523lm 2700° K CRI80 Dimmable 0-10V

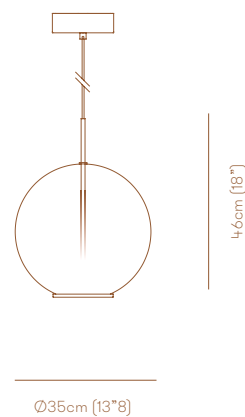
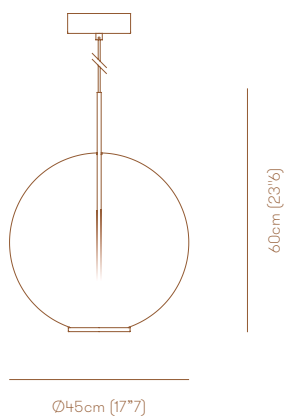

Ø 25: 1x5W LED 10V 676lm 2700° K CRI80 Dimmable 0-10V

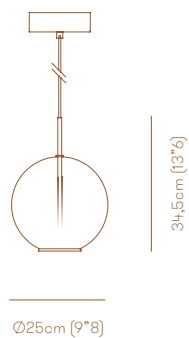



## MONDRIAN GLASS CEILING

Ceiling lamp with diffused light.  
Burnished natural brass, matte black nickel, polished black nickel or polished gold structure. White Murano blown glass diffusers.

Lampada da soffitto a luce diffusa.  
Struttura in ottone naturale brunito, nichel nero opaco, nichel nero lucido o oro lucido. Diffusori in vetro soffiato di Murano bianco.

## LIGHTING

P. 26

5x5W G9 LED 350lm 2700°K Dimmable

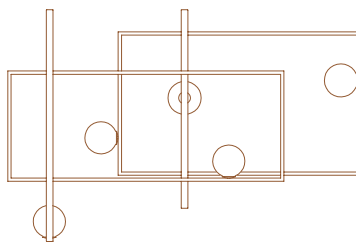

105cm (41"3)

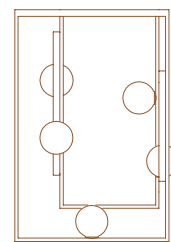

75cm (29"5)

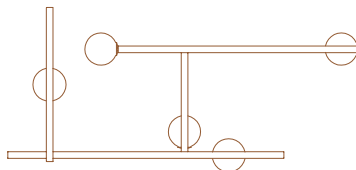

160cm (63")

## NUMA WALL

Wall lamp with diffused light. Dark burnished brass structure. Crystal, amber or smoke grey Murano blown glass trihedrons.

Lampada da parete a luce diffusa. Struttura in ottone brunito scuro. Triedri in vetro soffiato di Murano color cristallo, ambra o fumé.

## LIGHTING

P. 30

Strip LED 6W 24V 760lm 2700°K CRI80 Dimmable

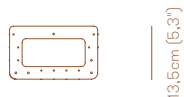
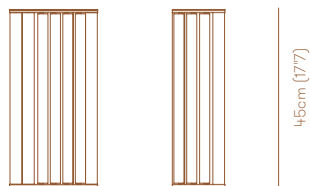

22,5cm (8,8")

## NUMA FLOOR

Floor lamp with diffused light. Dark burnished brass structure. Crystal, amber or smoke grey Murano blown glass trihedrons.

Lampada da terra a luce diffusa con struttura in ottone brunito scuro. Triedri in vetro soffiato di Murano color cristallo, ambra o fumé.

## LIGHTING

P. 28

Strip LED 40W 24V 5890lm 2700°K CRI80 Dimmable 0-10V

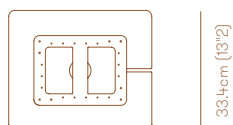
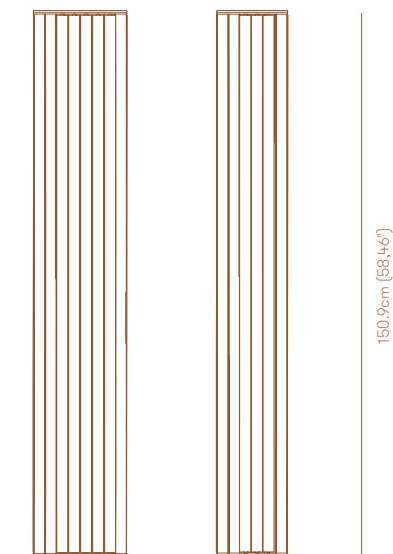

39,8cm (15.7)

## PINOCCHIO FLOOR

Floor lamp with diffused light.

Dark burnished brass structure with polished gold metal spheres or matte black nickel structure with polished black nickel spheres. Crystal, amber and smoke grey Murano blown glass trihedrons. White Murano blown glass diffusers.

Lampada da terra a luce diffusa.

Struttura in ottone brunito scuro con sfere di metallo oro lucido, o in nichel nero opaco con sfere di metallo nero lucido. Triedri in vetro soffiato di Murano color cristallo, ambra e fumé. Diffusori in vetro soffiato di Murano bianco.

## LIGHTING

P. 32

2x5W G9 LED 350lm 2700°K Dimmable

+ 2xStrip LED 7W 940lm 2700°K CR180

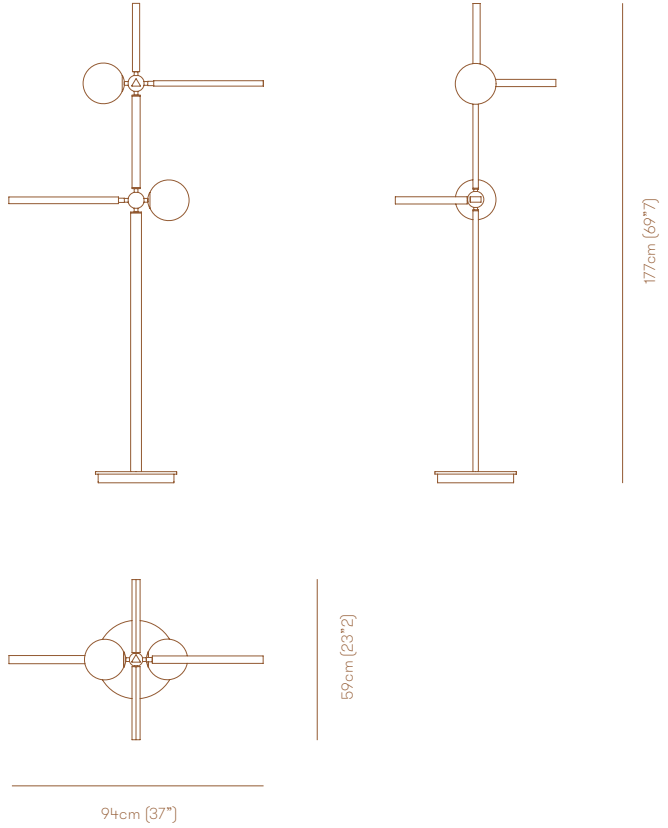

## RECTUS TABLE

Table lamp with directional light.  
Dark burnished brass structure and adjustable joint.

Lampada da tavolo a luce direzionabile. Struttura in ottone brunito scuro completa di snodo orientabile.

## LIGHTING

P. 34

1x6W GU10 PAR16 LED 560lm 2700°K CRI80 Dimmable

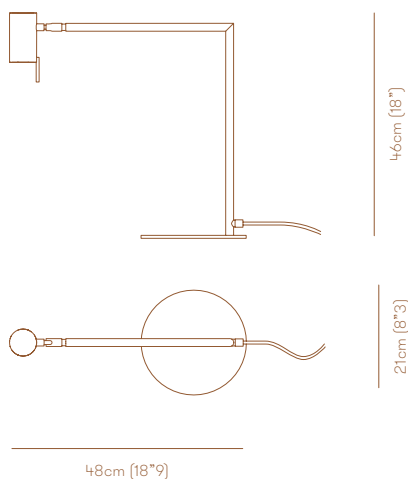

## RECTUS FLOOR

Floor lamp with directional light.  
Dark burnished brass structure and adjustable joint.

Lampada da terra a luce direzionabile. Struttura in ottone brunito scuro completa di snodo orientabile.

## LIGHTING

P. 34

1x6W GU10 PAR16 LED 560lm 2700°K CRI80 Dimmable

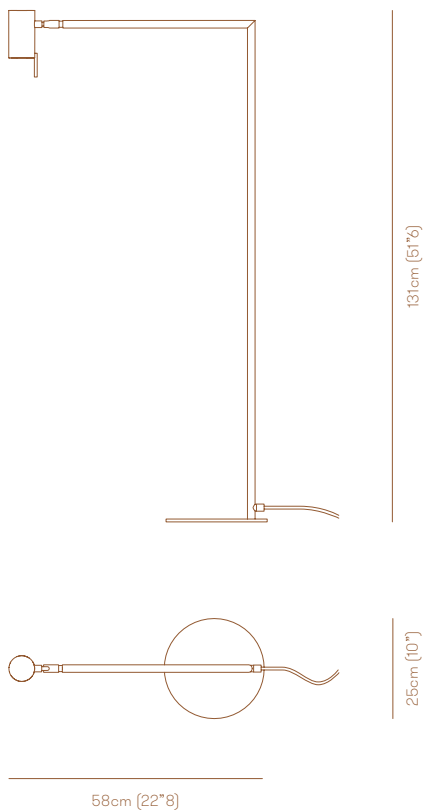

## SPEAR CHANDELIER SMALL

Suspended lamp with direct and indirect light. Light burnished brass, polished black nickel or matte black nickel structure. Strip LED inside the arms. Customizable in height.

Chandelier a luce diretta e indiretta. Struttura in Metallo con finitura in ottone brunito, nichel nero lucido o nichel nero opaco. Strip LED inserita all'interno delle braccia. Customizzabile in altezza.

## LIGHTING

1x16W LED 2360lm 2700°K CRI80 -dimmable 0-10V

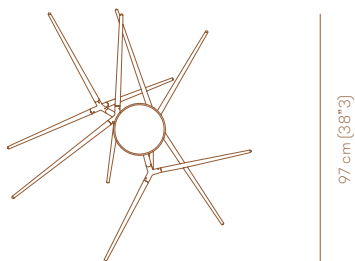
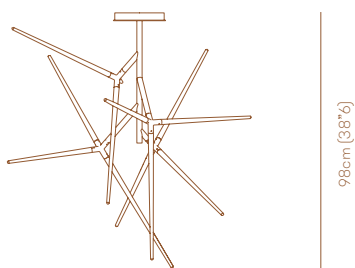

94 cm (37'')

## SPEAR CHANDELIER

Suspended lamp with direct and indirect light. Light burnished brass, polished black nickel or matte black nickel structure. Strip LED inside the arms. Customizable in height.

Chandelier a luce diretta e indiretta. Struttura in Metallo con finitura in ottone brunito, nichel nero lucido o nichel nero opaco. Strip LED inserita all'interno delle braccia. Customizzabile in altezza.

## LIGHTING

P. 36

1x25W LED 2570lm 2700°K CRI80 Dimmable 0-10V

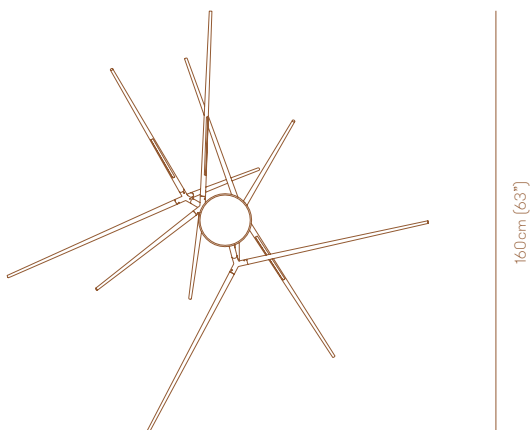
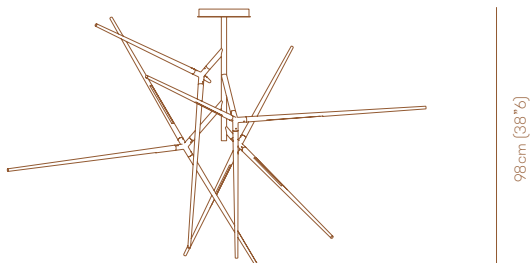

160cm (63'')

## URBAN LIGHTLINE SUSPENSION

Suspended lamp with direct and indirect light. Metal structure with light burnished brass finish and matte black perforated metal lampshade. Adjustable in height with steel cables.

Lampada a sospensione a luce diretta e indiretta. Struttura in metallo con finitura in ottone brunito chiaro e diffusore in rete metallica microforata nero opaco. Regolabile in altezza con cavi d'acciaio.

## LIGHTING P. 42

1x50W LED 5475lm 2700°K CRI90 Dimm. 0-10V.

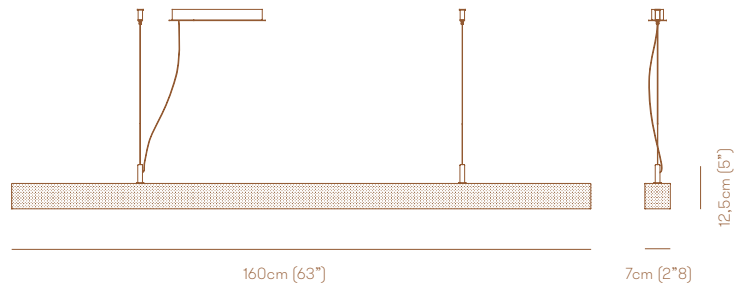

## URBAN LIGHTLINE WALL

Wall lamp with indirect light. Metal structure with light burnished brass finish and matte black perforated metal lampshade.

Lampada da parete a luce indiretta. Struttura in metallo con finitura ottone brunito chiaro e diffusore in rete metallica microforata nero opaco.

## LIGHTING P. 44

1x13W LED 1330lm 2700°K CRI90 Dimmable 0-10V.

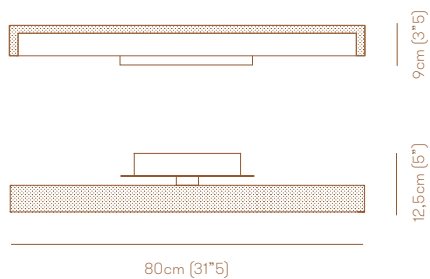

## VCM SYSTEM

Suspended lamp with direct downward light. Dark burnished brass structure and cable-mounting system.

Lampada a sospensione a luce diretta verso il basso. Struttura in ottone brunito scuro e sistema di montaggio su cavi.

## LIGHTING

P. 40

1x17W LED 1800lm 2700°K CRI90 Dimmable 0-10V.

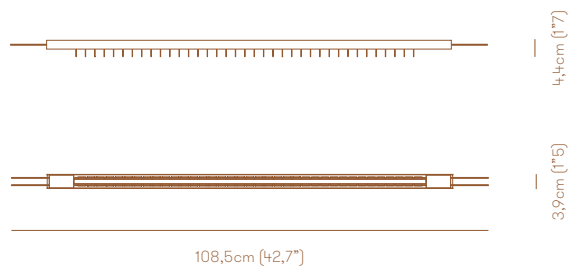

## EQUILIBRE COFFEE TABLE

Coffee table composed of smoke grey or sea blue blown glass bearing structure. Delabré copper or delabré brass top.

Tavolino con struttura portante in vetro soffiato grigio fumé o blu mare. Piano in rame o ottone delabré.

## FURNITURE

P. 48

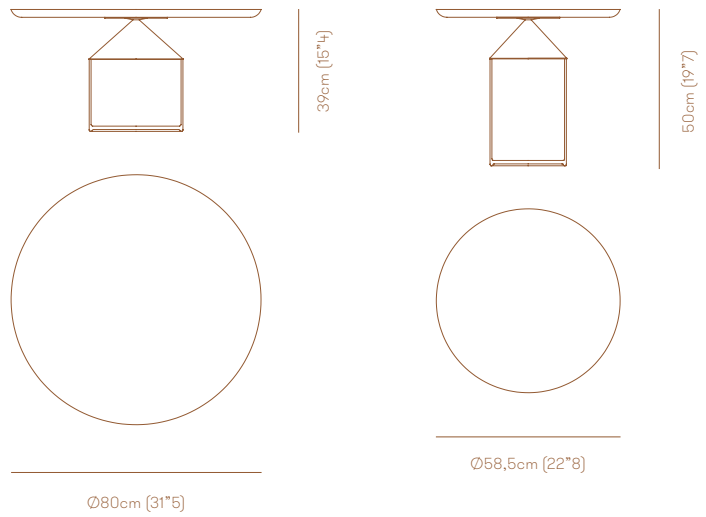

## SERGE CABINET

Madia composed of aluminium profiles, bronze finish and matte black lacquered body. Bronze antique mirror top.

Madia con profili in alluminio, finitura in bronzo striato scuro e scocca in laccato nero opaco. Top in specchio antichizzato bronzo.

## FURNITURE

P. 50

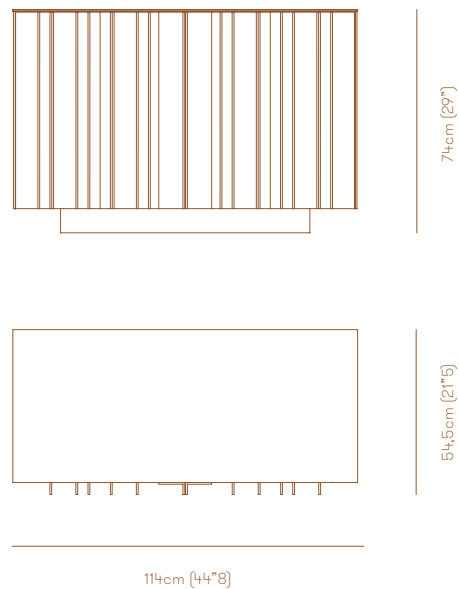



## URBAN COFFEE TABLE

Coffee table composed of metal bearing structure with light burnished brass finish. matte black perforated metal top.

Tavolino con struttura portante in metallo con finitura ottone brunito chiaro. Piano in metallo microforato nero opaco.

## FURNITURE

P. 52

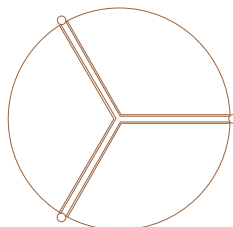
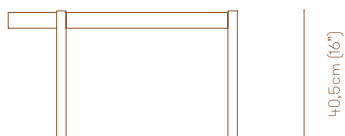

Ø70cm (27"5)

## WAVE COFFEE TABLE

Coffee table composed of curved smoke grey glass bearing structure. Light burnished brass top.

Tavolino con struttura portante in vetro grigio curvato. Piano in ottone brunito chiaro.

## FURNITURE

P. 54

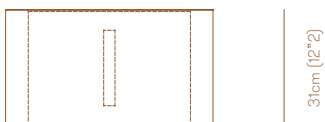
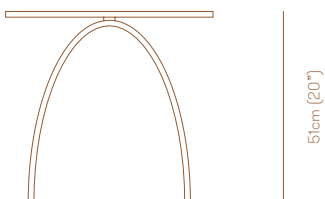

55cm (21"7)

31cm (12"2)

## Concept & Graphic Design

Ottone Studio

## Photographer

Federico Marin

## Selection & Post Productions

Luce Group

## Print

Grafiche Antiga

VeniceM si riserva il diritto di apportare, senza preavviso, ogni modifica mirata al miglioramento funzionale e qualitativo dei prodotti. Testi e disegni presenti in questo stampato hanno scopo divulgativo: per ogni aspetto tecnico e dimensionale fare riferimento ai listini aziendali e relativi aggiornamenti. I campioni di colore e materiali hanno valore indicativo.

VeniceM reserves the rights at all time to apply modifications for the functional or qualitative improvement of its products. Texts and drawings present in this brochure have a divulgative purpose: for every technical and dimensional aspect please refer to the company's price lists and their relative updatings. The colour and material samples have an indicative value.

© VeniceM - Tutti i diritti sono riservati a norma di legge / All rights reserved

Il marchio VeniceM è proprietà della VeniceM srl / Trade Mark VeniceM

## VENICEM S.R.L.

via Terraglio, 54  
31021 Mogliano Veneto (TV)  
Italy

T / F (+39) 041 593 6143

info@venicem.com

www.venicem.com



