

S C U L

T U R E

D I

L U C E

VENICEM

S C U L

T U R E

D I

L U C E

VENICEM

INDEX

| | |
|----------------|-----|
| PINOCCHIO | 8 |
| URBAN | 16 |
| KITAMI | 40 |
| MONDRIAN | 56 |
| CIRCLE | 84 |
| ZOE | 94 |
| SECRET | 104 |
| NUMA | 114 |
| CHIC | 118 |
| CROWN | 122 |
| ROOTS | 130 |
| TECHNICAL DATA | 137 |



TIMELESS

Melissa e Massimo, dopo un proprio personale percorso di lavoro nel campo dell'illuminazione e del design d'interni, si uniscono e fondano nel 2013 VeniceM.

Ogni oggetto è ideato e pensato per dare un forte segno di riconoscibilità alla collezione VeniceM. Le forme semplici e la chiarezza nell'uso dei materiali sono contraddistinti dalla continua ricerca e la cura nei prodotti.

L'utilizzo di materiali nobili, l'ossidazione dell'ottone, l'imperfezione-perfezione del vetro, sono tra di loro combinati per dare forza ad oggetti "senza tempo".

Melissa and Massimo, after their own personal path in the field of lighting and interior design, joined together and founded in 2013 VeniceM. Each object is designed and created with the purpose of giving a strong sign of recognition to VeniceM collection and brand.

Simple forms and clarity in the use of materials are distinguished by the continuous research and product care.

The use of noble materials, brass oxidation, imperfection and perfection of glass are combined together to give strength to "timeless" objects.















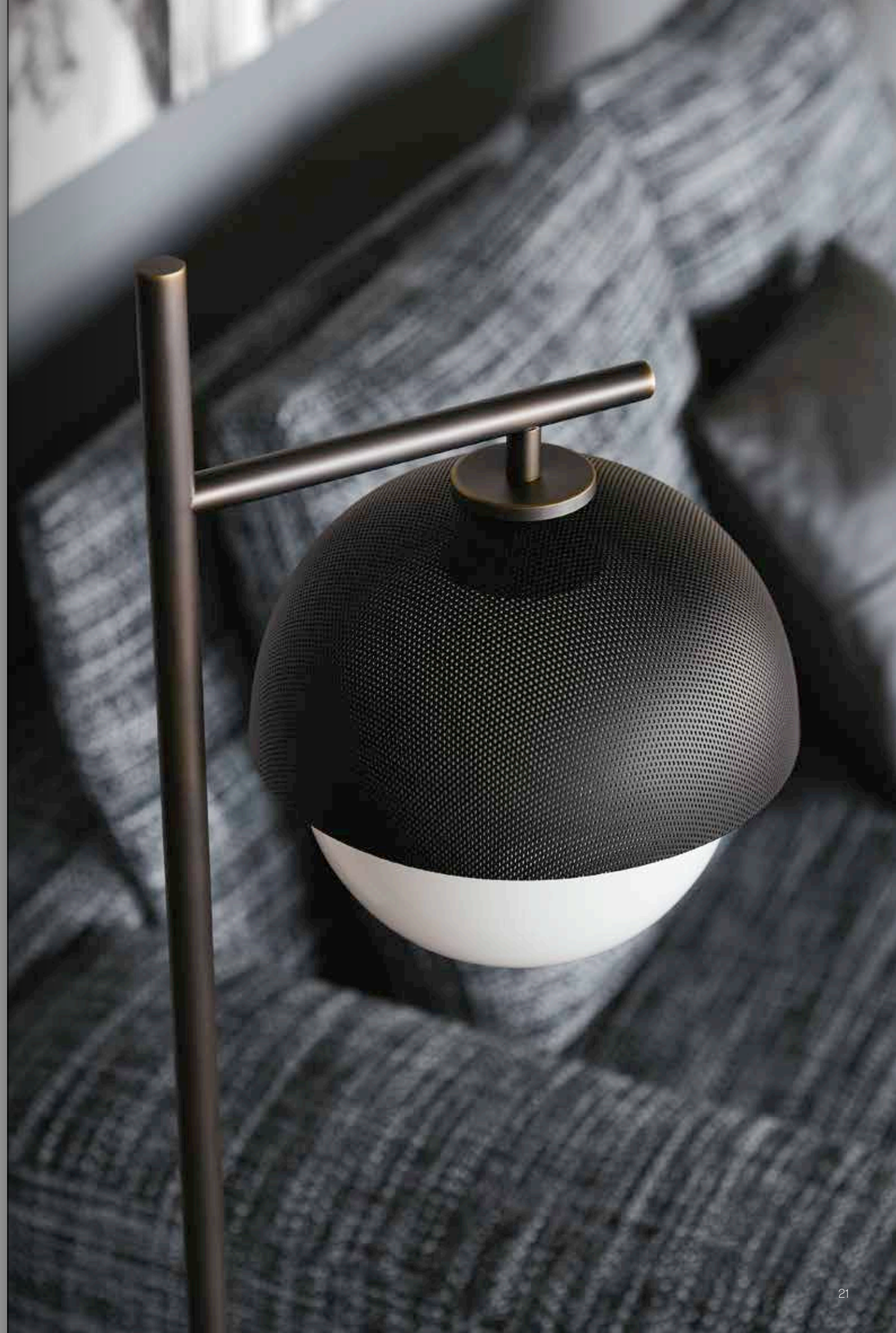



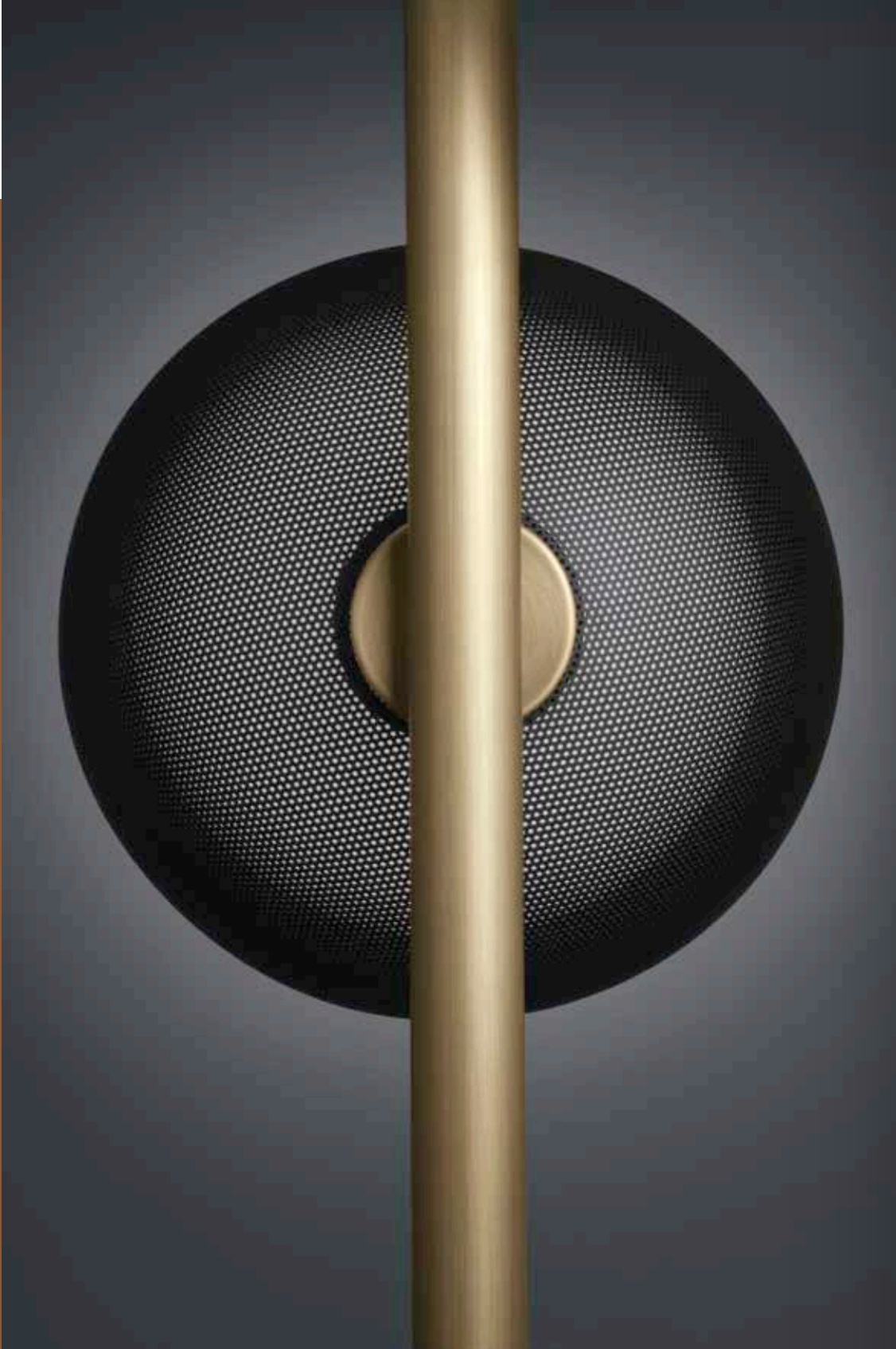



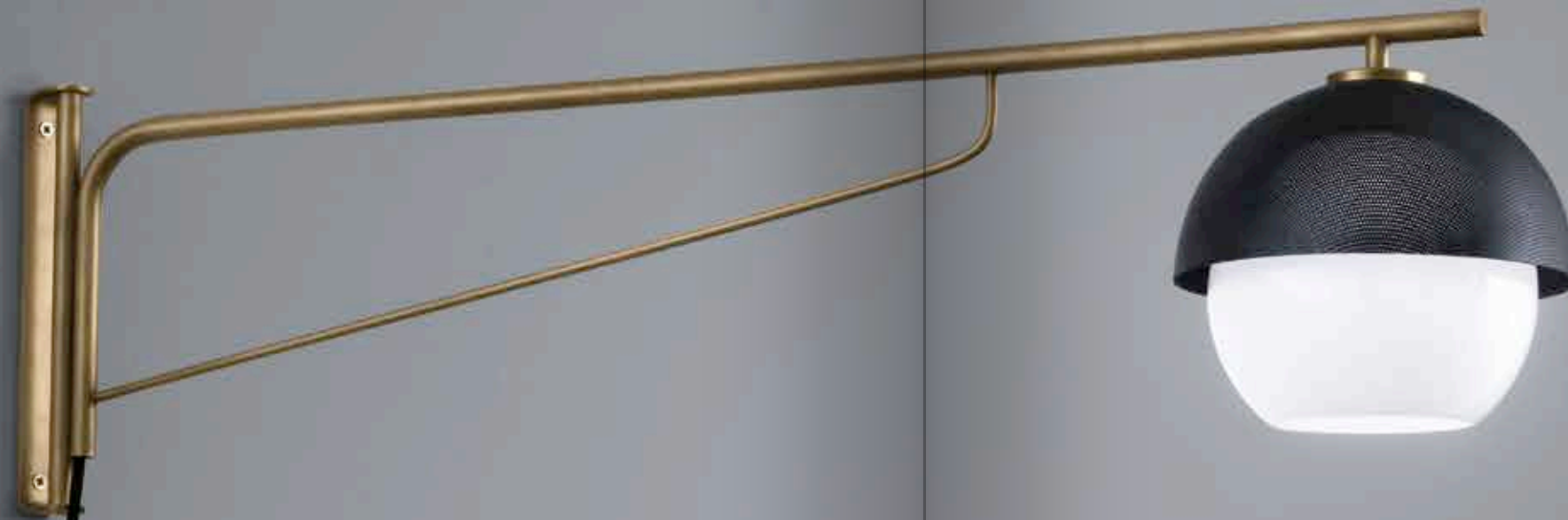











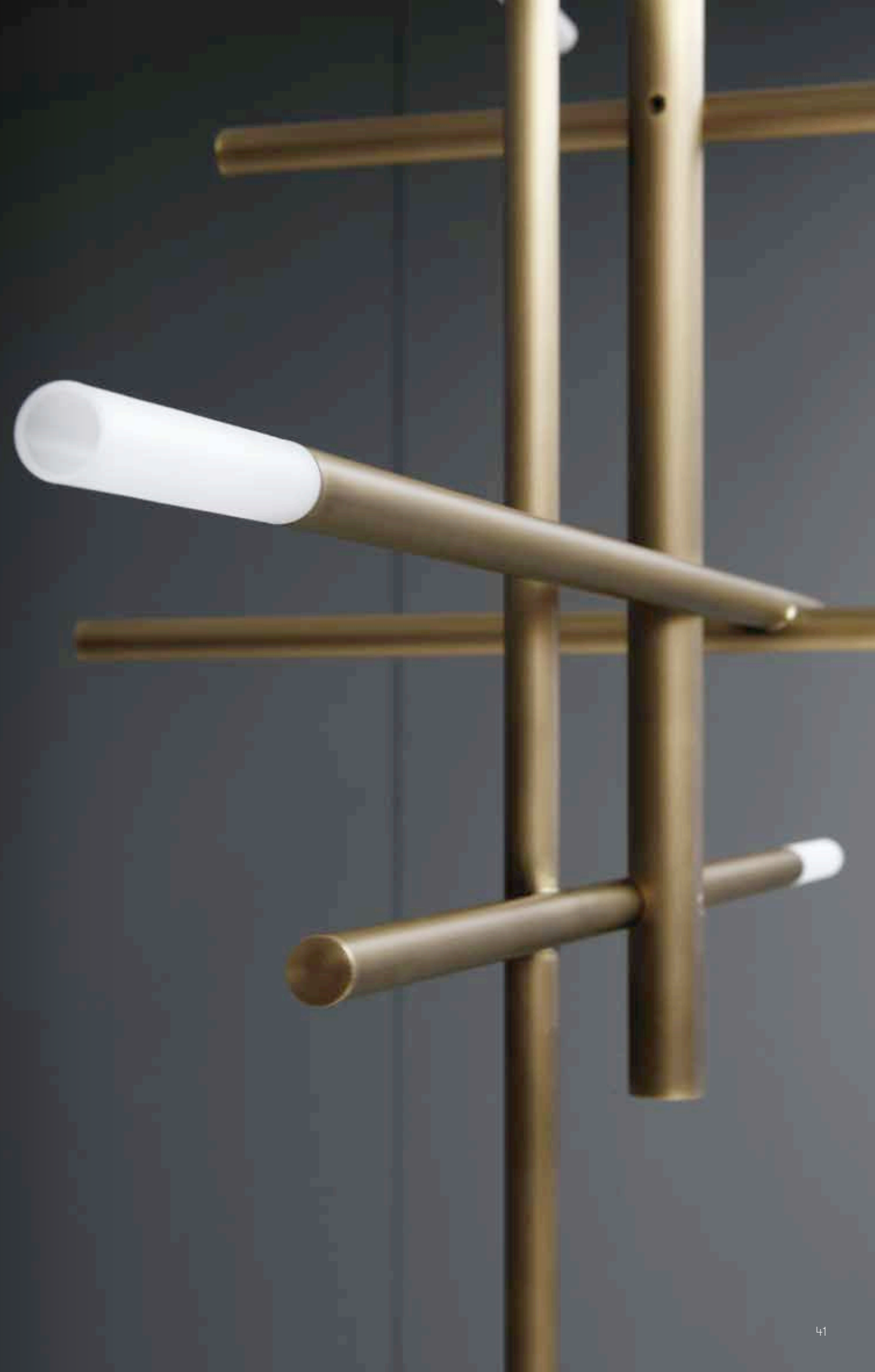

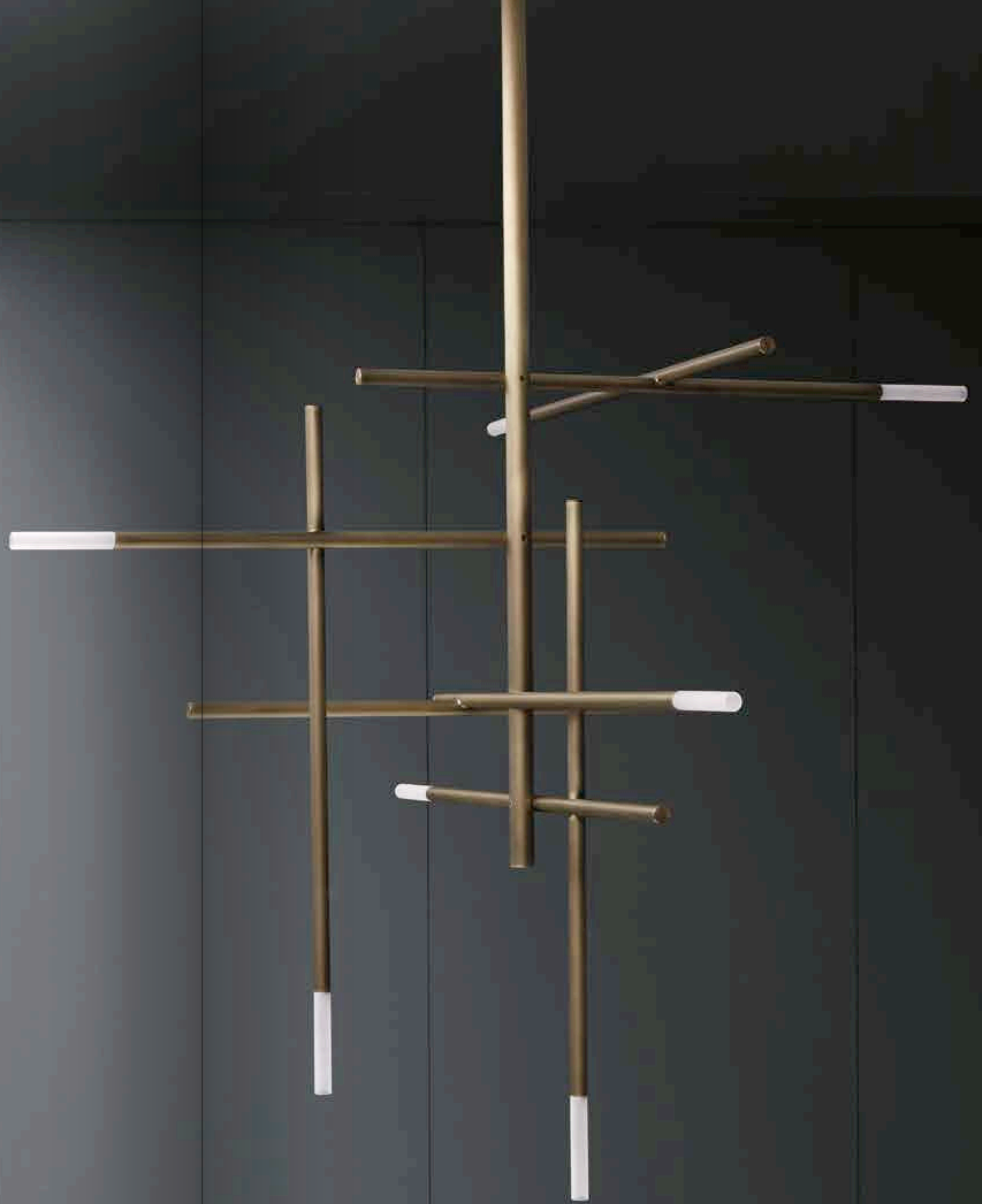

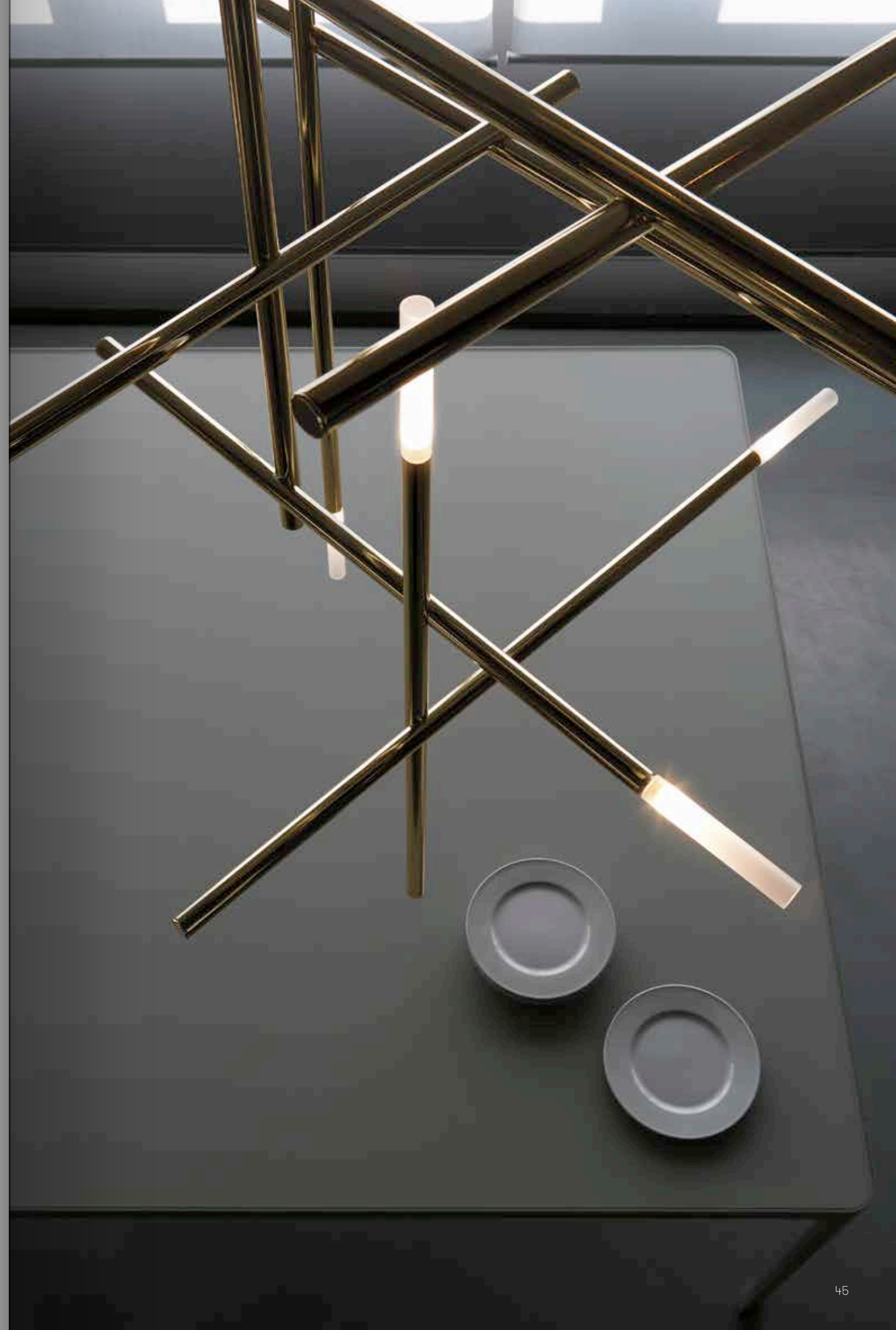









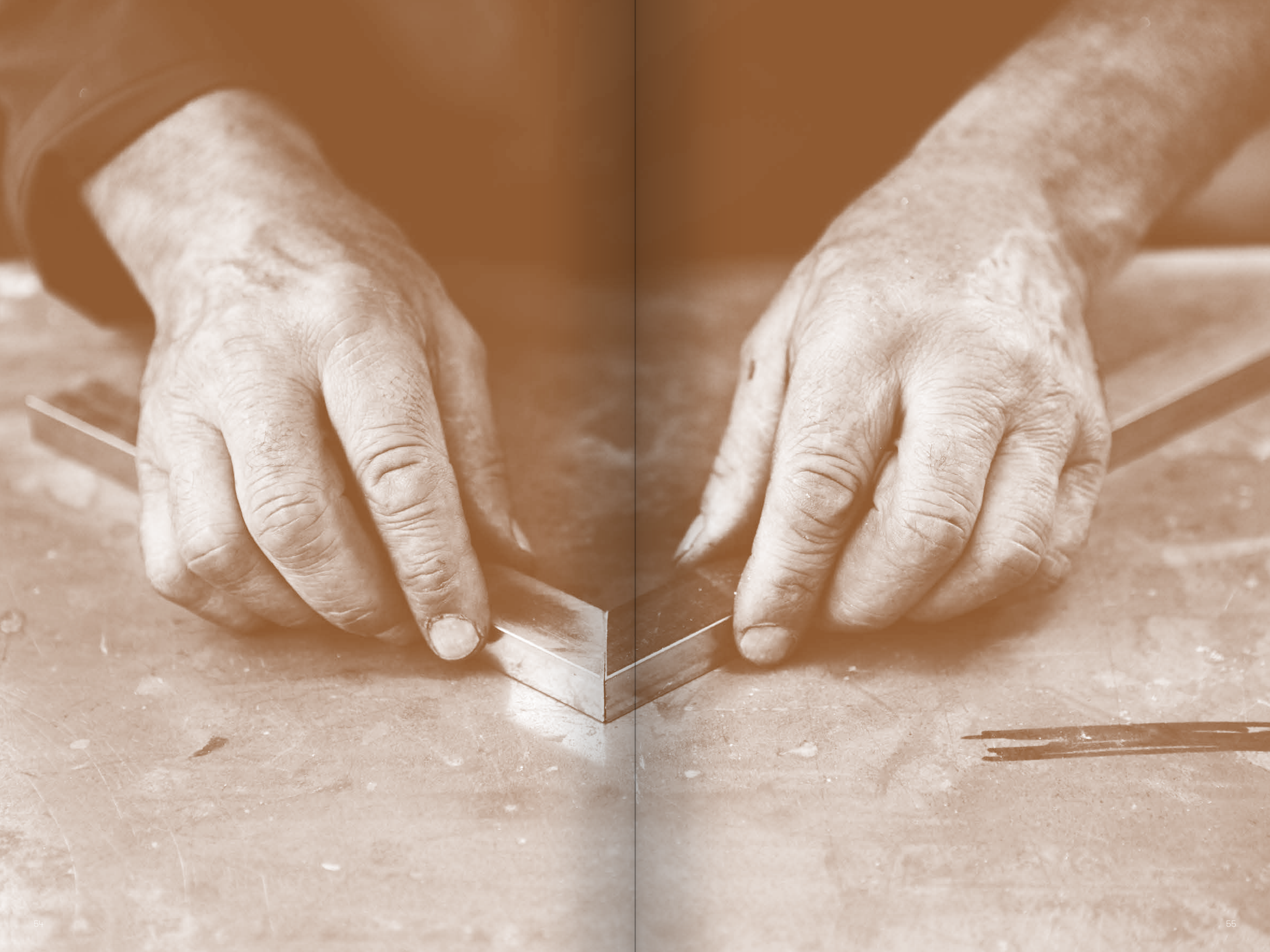





MONDRIAN GLASS FLOOR















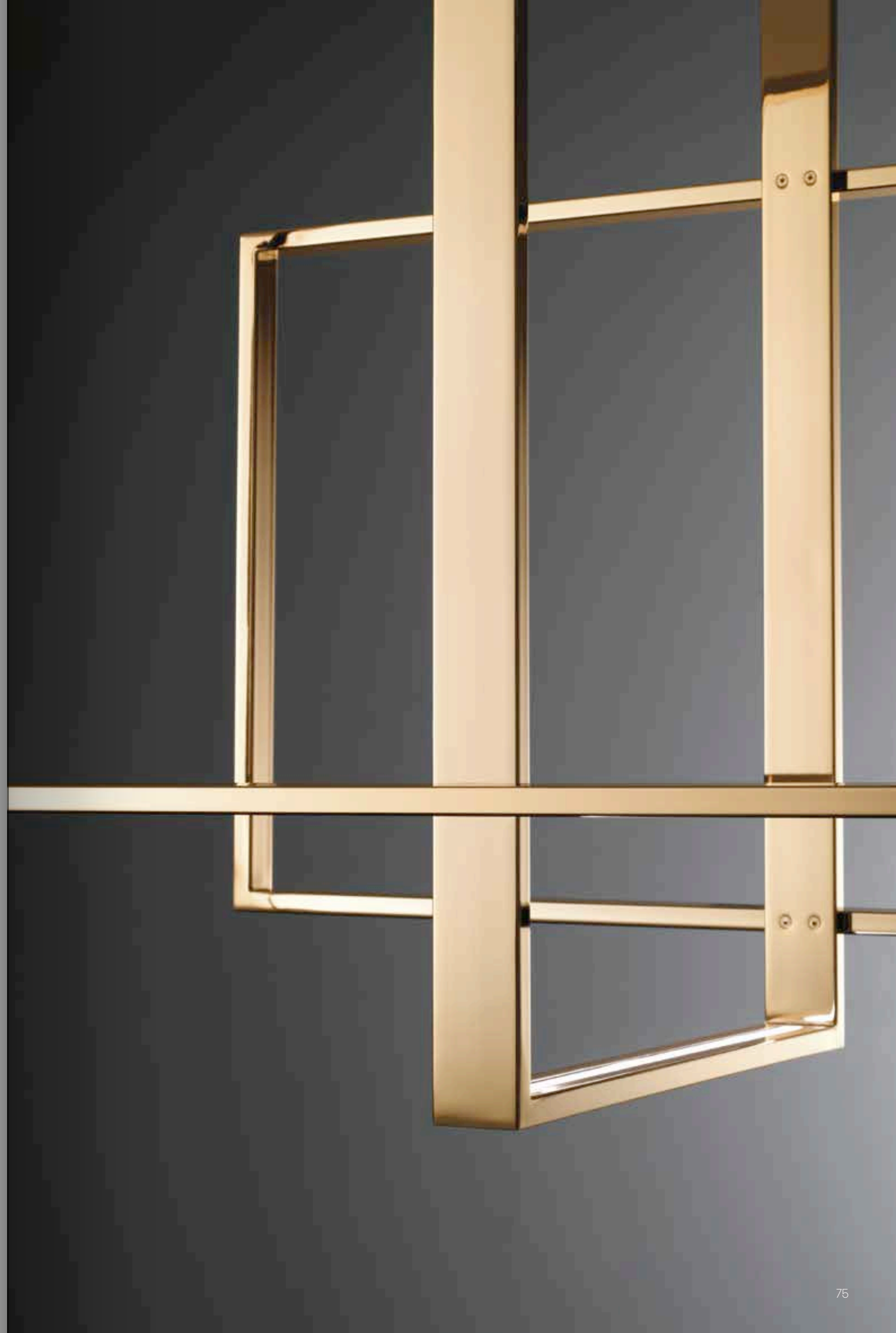
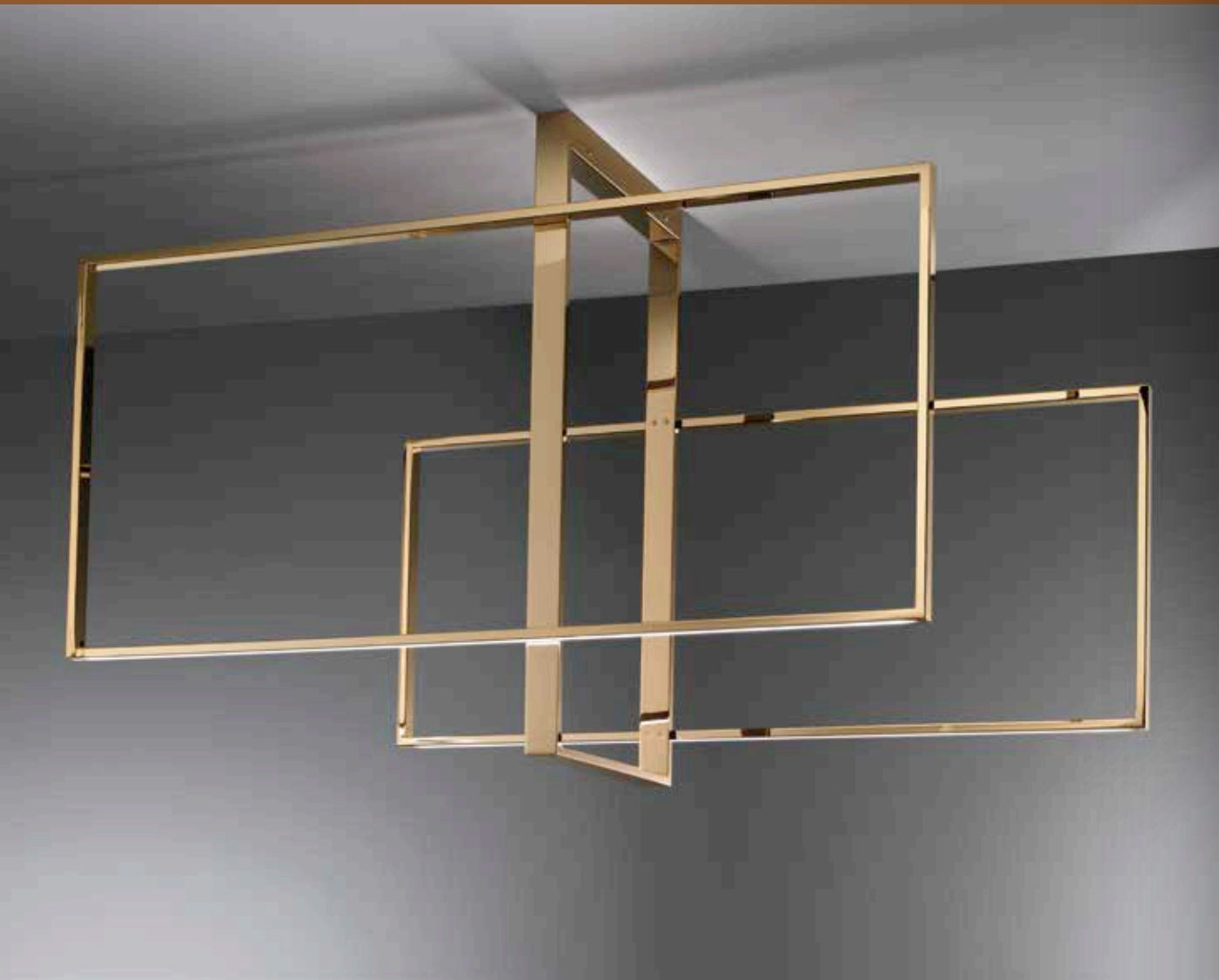













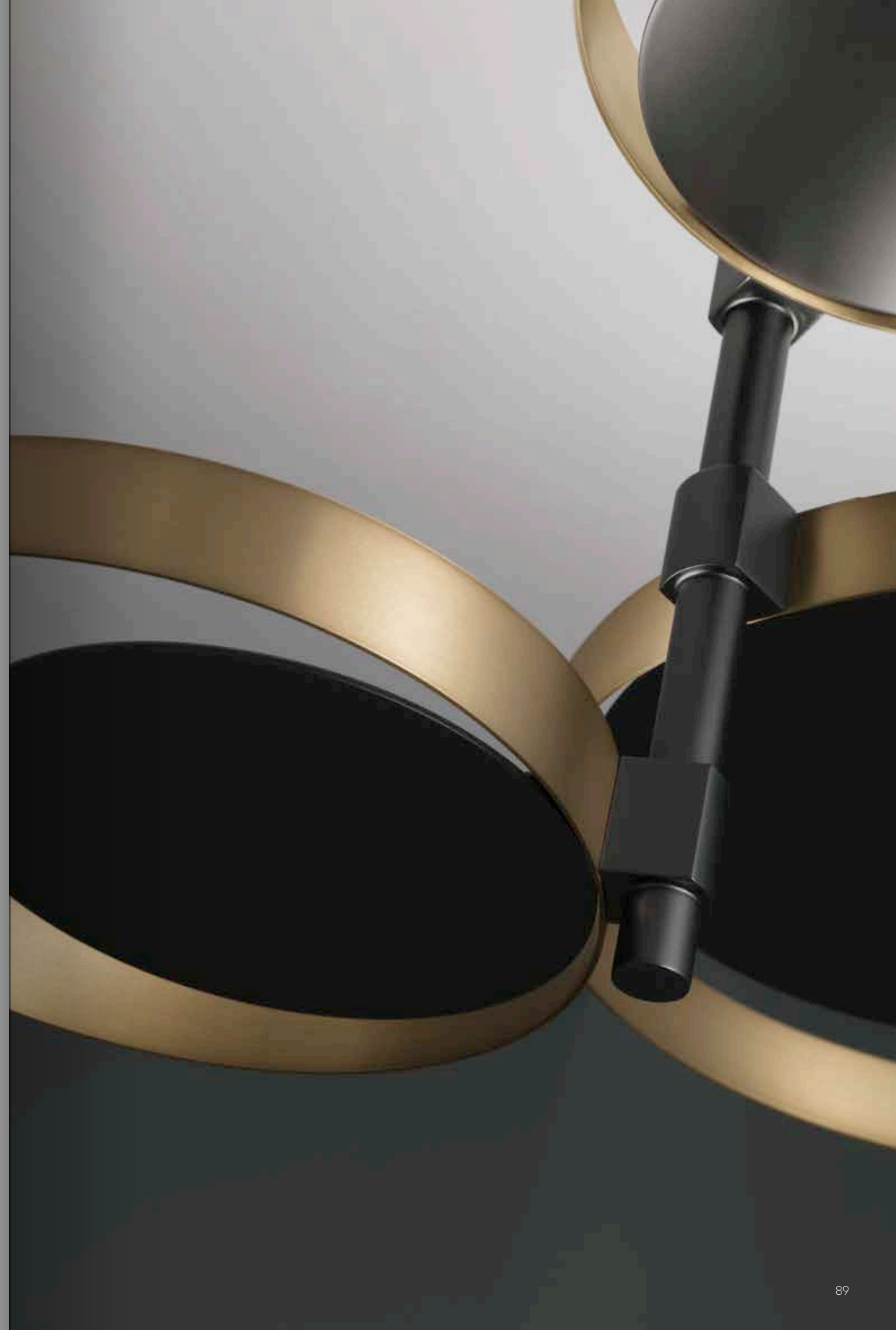



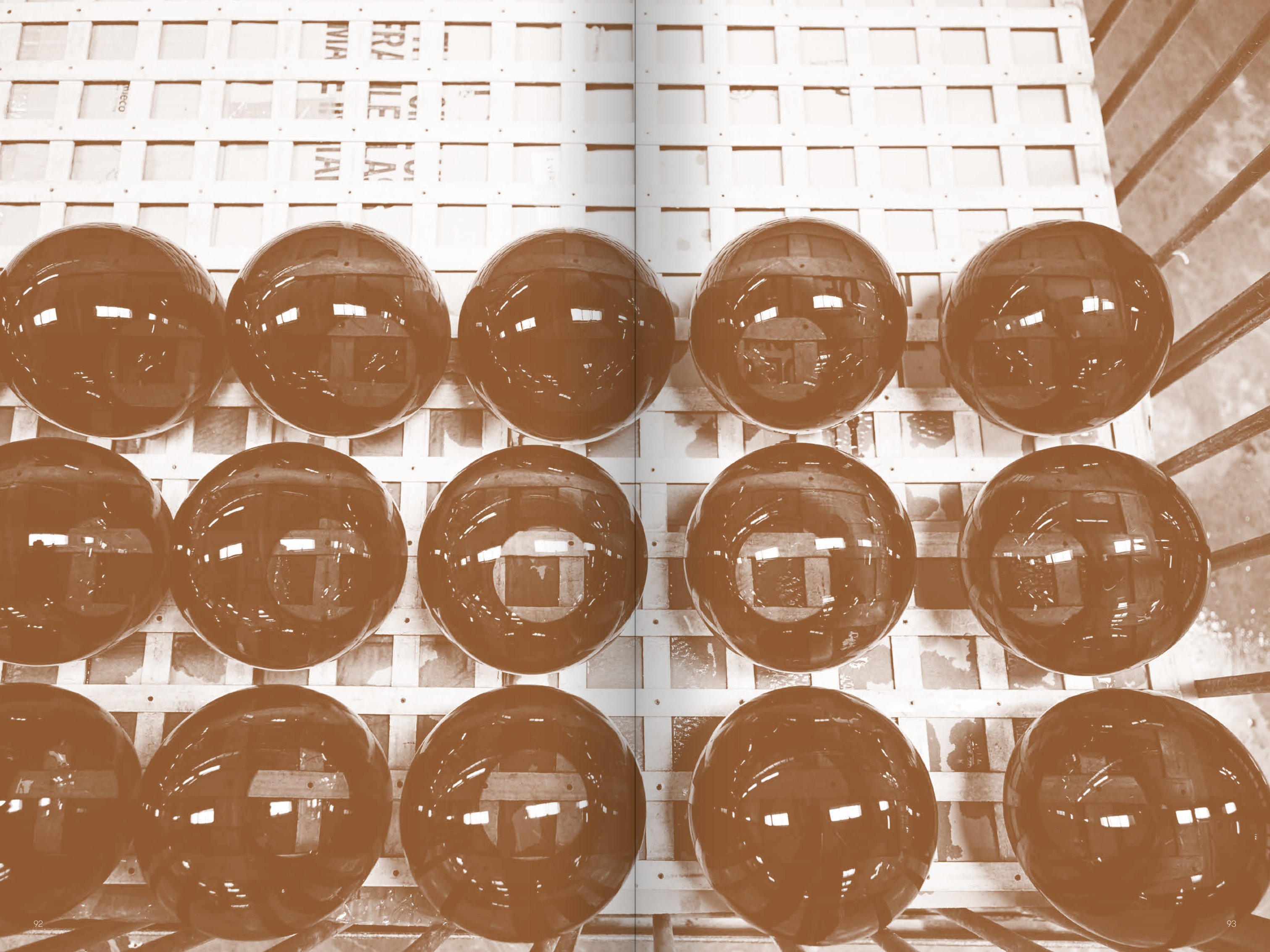





































ROOTS CHANDELIER







TECHNICAL DATA

CHIC
CIRCLE
CROWN
KITAMI
MONDRIAN
NUMA
PINOCCHIO
ROOTS
SECRET
URBAN
ZOE

CHIC FLOOR

Floor lamp with diffused light. Dark bronze striped structure and crystal Murano blown glass trihedrons.

Lampada da terra a luce diffusa. Struttura in bronzo striato scuro e triedri in vetro soffiato di Murano color cristallo.

P. 118

1x75W E27 PAR30 halogen 650lm 2900°K
+ 1x53W E27 halogen 1320lm 2800°K
or
1x9W E27 PAR30 LED 766lm 2700°K
+ 1x7W E27 LED 560lm 2700°K

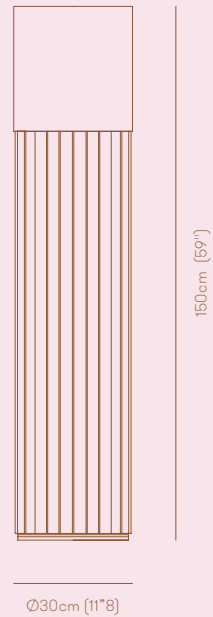

CHIC TABLE

Table lamp with diffused light. Dark bronze striped structure and crystal Murano blown glass trihedrons.

Lampada da tavolo a luce diffusa. Struttura in bronzo striato scuro e triedri in vetro soffiato di Murano color cristallo.

P. 120

1x35W GU10 PAR16 halogen 200lm 2700°K
+ 1x30W E14 halogen 405lm 2700°K
or
1x4,3W GU10 PAR16 LED 350lm 2700°K
+ 1x5,7W E14 LED 470lm 2700°K

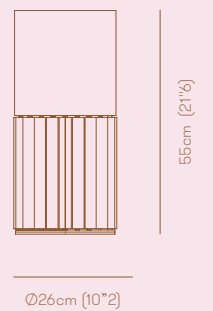

CIRCLE WALL 25/35

Wall lamp with indirect light. Satinated natural brass ring and matte black nickel structure.

Lampada da parete a luce indiretta. Anello in ottone naturale satinato e struttura in nichel nero opaco.

P. 84

1x17W 1500lm 2700°K CRI90

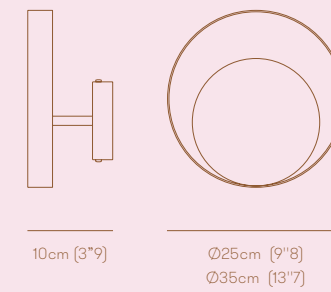

CIRCLE CEILING

Ceiling lamp with indirect light. Satinated natural brass rings and matte black nickel structure.

Lampada da soffitto a luce indiretta. Anelli in ottone naturale satinato e struttura in nichel nero opaco.

P. 88

3x17W 1500lm 2700°K CRI90

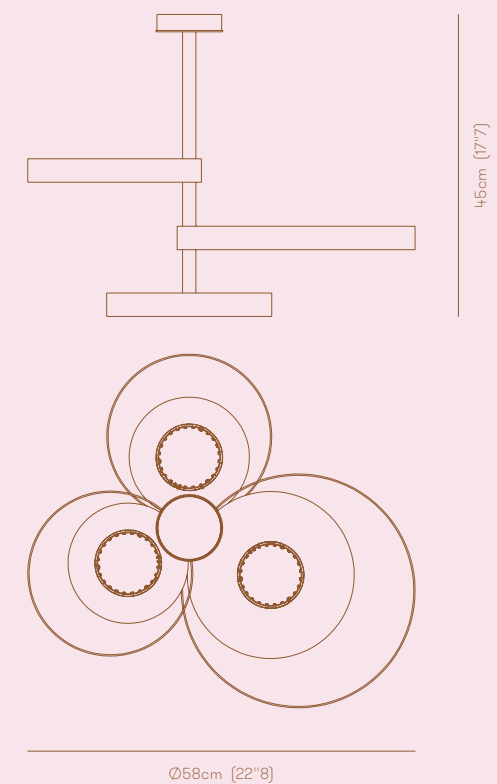

CROWN SUSPENSION

Suspended lamp with diffused light. Dark bronze striped structure and crystal, amber or smoke grey Murano blown glass trihedrons.

Lampada a sospensione a luce diffusa. Struttura in bronzo striato scuro e triedri in vetro soffiato di Murano color cristallo, ambra o grigio fumé.

P. 122

5×53W E27 halogen 1320lm 2800°K
or 5×7W E27 LED 560lm 2700°K

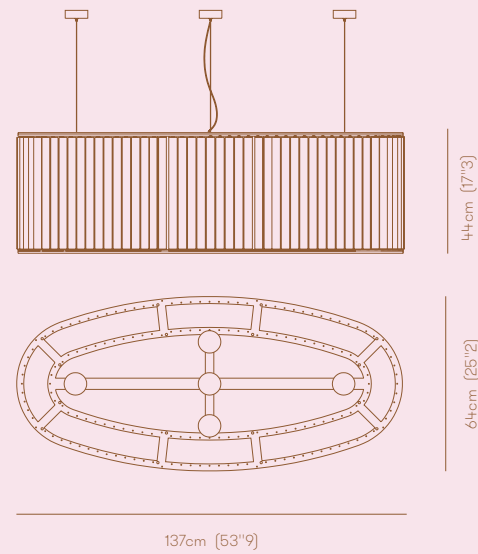

CROWN WALL

Wall lamp with diffused light. Dark bronze striped structure and crystal, amber or smoke grey Murano blown glass trihedrons.

Lampada da parete a luce diffusa. Struttura in bronzo striato scuro e triedri in vetro soffiato di Murano color cristallo, ambra o grigio fumé.

P. 126

1×53W E27 halogen 1320lm 2800°K
or 1×7W E27 LED 560lm 2700°K

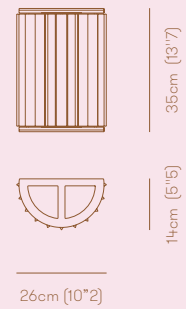

KITAMI SUSPENSION

Suspended lamp with diffused light. Polished black nickel, polished gold or light burnished brass structure and satinated glass diffusers.

Lampada a sospensione a luce diffusa. Struttura in nichel nero lucido, oro lucido od ottone brunito chiaro e diffusori in vetro satinato.

P. 40

LARGE
8×2W G4 LED 200lm 2700°K
MEDIUM
6×2W G4 LED 200lm 2700°K

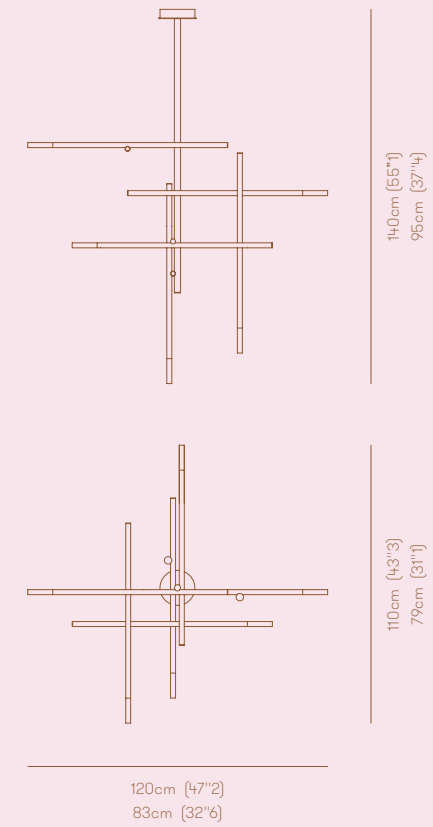

KITAMI WALL

Wall lamp with diffused light. Polished black nickel, polished gold or light burnished brass structure and satinated glass diffusers.

Lampada da parete a luce diffusa. Struttura in nichel nero lucido, oro lucido od ottone brunito chiaro e diffusori in vetro satinato.

P. 46

4×2W G4 LED 200lm 2700°K

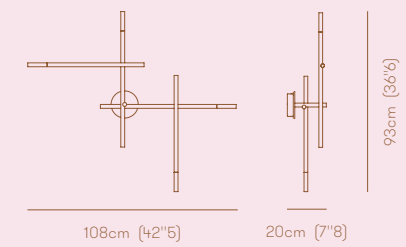

MONDRIAN GLASS CEILING

Ceiling lamp with diffused light.
Burnished natural brass, polished black nickel or polished gold structure and white, amethyst or smoke grey Murano blown glass diffusers.

Lampada da soffitto a luce diffusa.
Struttura in ottone naturale brunito, nichel nero lucido od oro lucido e diffusori in vetro soffiato di Murano color bianco, ametista o grigio fumé.

P. 56

5×MAX 33W G9 halogen 460lm 2700°K
or 5×4,5W G9 LED 350lm 2700°K

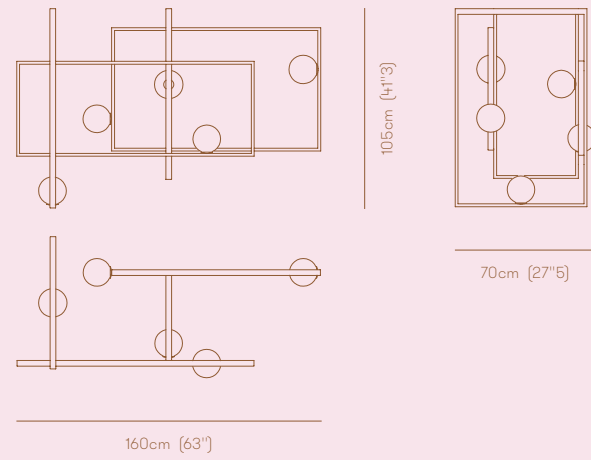

MONDRIAN GLASS FLOOR

Floor lamp with diffused light.
Burnished natural brass, polished black nickel or polished gold structure and white, amethyst or smoke grey Murano blown glass diffusers.

Lampada da terra a luce diffusa.
Struttura in ottone naturale brunito, nichel nero lucido od oro lucido e diffusori in vetro soffiato di Murano color bianco, ametista o grigio fumé.

P. 60

3×MAX 33W G9 halogen 460lm 2700°K
or 3×4,5W G9 LED 350lm 2700°K

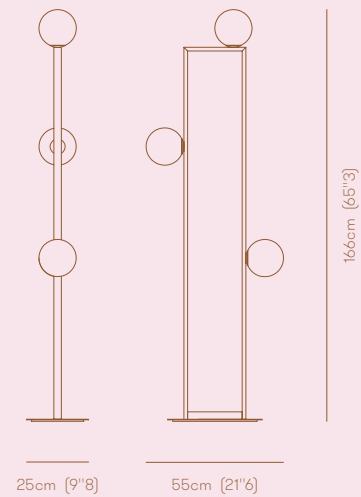

MONDRIAN GLASS WALL

Wall lamp with diffused light.
Burnished natural brass, polished black nickel or polished gold structure and white, amethyst or smoke grey Murano blown glass diffuser.

Lampada da parete a luce diffusa.
Struttura in ottone naturale brunito, nichel nero lucido od oro lucido e diffusore in vetro soffiato di Murano color bianco, ametista o grigio fumé.

P. 64

1×MAX 33W G9 halogen 460lm 2700°K
or 1×4,5W G9 LED 350lm 2700°K

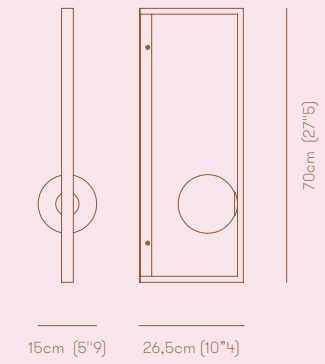

MONDRIAN LED CEILING

Ceiling lamp with direct and indirect light. Polished black nickel, polished gold or light burnished brass structure.

Lampada da soffitto a luce diretta e indiretta. Struttura in nichel nero lucido, oro lucido od ottone brunito chiaro.

P. 70

Strip LED 34W 2265lm 2700°K CRI85

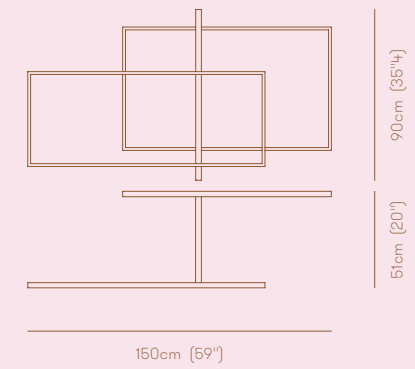

MONDRIAN LED WALL

Wall lamp with direct and indirect light. Polished black nickel, polished gold or light burnished brass structure.

Lampada da parete a luce diretta e indiretta. Struttura in nichel nero lucido, oro lucido od ottone brunito chiaro.

P. 76

Strip LED 16W 1025lm 2700°K CRI85

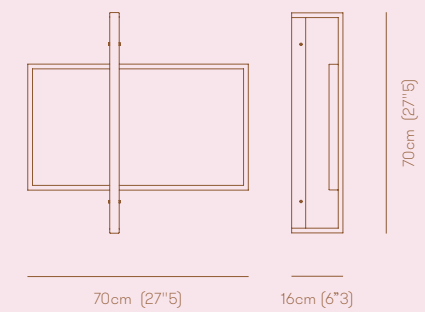

NUMA SUSPENSION

Suspended lamp with diffused light. Dark burnished brass structure and crystal Murano blown glass trihedrons.

Lampada a sospensione a luce diffusa. Struttura in ottone brunito scuro e triedri in vetro soffiato di Murano color cristallo.

P. 114

1x17W LED 1500lm 2700°K CRI90

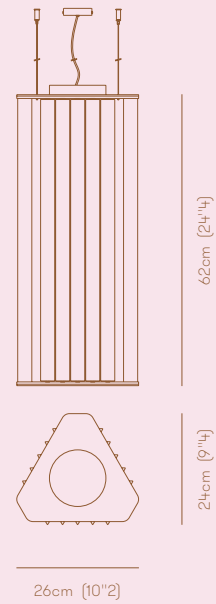

PINOCCHIO FLOOR

Floor lamp with diffused and direct light. Dark burnished brass structure with polished gold metal spheres. White Murano blown glass diffusers and crystal Murano blown glass trihedrons.

Lampada da terra a luce diffusa e diretta. Struttura in ottone brunito scuro con sfere di metallo in oro lucido. Diffusori in vetro soffiato di Murano color bianco e triedri in vetro soffiato di Murano color cristallo.

P. 8

2xMAX 33W G9 halogen 460lm 2700°K
+ Strip LED 9W 580lm 2700°K CRI85
or
2x4,5W G9 LED 350lm 2700°K
+ Strip LED 9W 580lm 2700°K CRI85

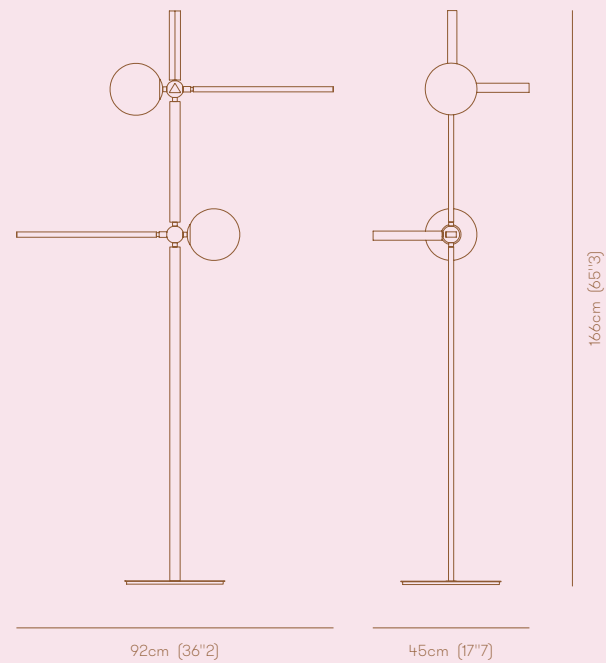

ROOTS CHANDELIER

Suspended lamp diffused light. Light burnished brass structure and clear or white Murano blown glass diffusers.

Lampada a sospensione a luce diffusa. Struttura in ottone brunito chiaro e diffusori in vetro soffiato di Murano color trasparente o bianco.

P. 130

10x4,5W G9 LED 350lm 2700°K

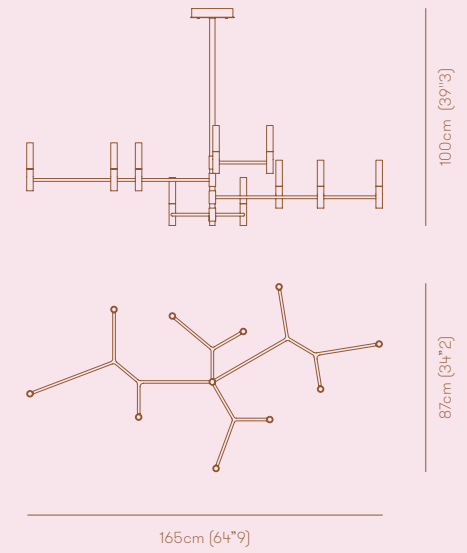

ROOT ONE WALL

Wall lamp with diffused light. Light burnished brass structure and clear or white Murano blown glass diffuser.

Lampada da parete a luce diffusa. Struttura in ottone brunito chiaro e diffusore in vetro soffiato di Murano color trasparente o bianco.

P. 134

1x4,5W G9 LED 350lm 2700°K

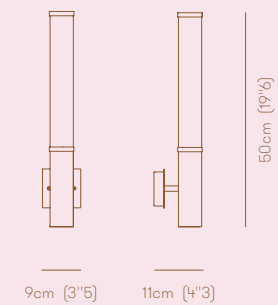

SECRET FLOOR

Floor lamp with indirect light.
Satinated natural brass and matte
black nickel structure.

Lampada da terra a luce indiretta.
Struttura in ottone naturale satinato
e nichel nero opaco.

P. 104

Strip LED 36W 2400lm 2700°K CR85

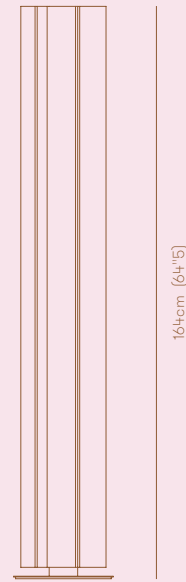

164cm (64"6)

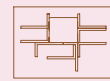

22cm (8"6)

30cm (11"8)

SECRET WALL

Wall lamp with indirect light.
Satinated natural brass and matte
black nickel structure.

Lampada da parete a luce indiretta.
Struttura in ottone naturale satinato
e nichel nero opaco.

P. 108

Strip LED 16W 1060lm 2700°K CRI85

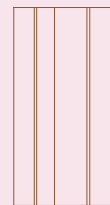

50cm (19"6)

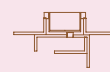

13,5cm (5"3)

25cm (9"8)

URBAN CEILING

Ceiling lamp with diffused light. Light
or dark burnished brass structure
with matte gold or matte black
perforated metal lampshade.
White Murano blown glass diffuser.

Lampada da soffitto a luce diffusa.
Struttura in ottone brunito chiaro
o scuro con paralume in metallo
microforato color oro opaco o nero
opaco. Diffusore in vetro soffiato di
Murano color bianco.

P. 34

1xMAX 33W G9 halogen 460lm 2700°K
or 1x4,5W G9 LED 350lm 2700°K

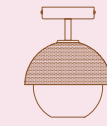

26cm (9"8)

Ø20cm (7"8)

URBAN WALL

Wall lamp with diffused light. Light or
dark burnished brass structure with
matte gold or matte black perforated
metal lampshade. White Murano
blown glass diffuser.

Lampada da parete a luce diffusa.
Struttura in ottone brunito chiaro
o scuro con paralume in metallo
microforato color oro opaco o nero
opaco. Diffusore in vetro soffiato di
Murano color bianco.

P. 34

1xMAX 33W G9 halogen 460lm 2700°K
or 1x4,5W G9 LED 350lm 2700°K

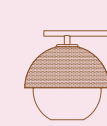

26cm (10")

25cm (9"8)

URBAN SUSPENSION 1

Suspended lamp with diffused
light. Light or dark burnished brass
structure with matte gold or matte
black perforated metal lampshade.
White Murano blown glass diffuser.

Lampada a sospensione a luce
diffusa. Struttura in ottone brunito
chiaro o scuro con paralume in
metallo microforato color oro opaco
o nero opaco. Diffusore in vetro
soffiato di Murano color bianco.

P. 36

1xMAX 33W G9 halogen 460lm 2700°K
or 1x4,5W G9 LED 350lm 2700°K

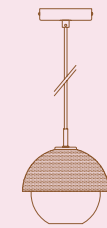

150cm (59")

Ø20cm (7"8)

URBAN SUSPENSION 3

Suspended lamp with diffused light. Light or dark burnished brass structure with matte gold or matte black perforated metal lampshades. White Murano blown glass diffusers.

Lampada a sospensione a luce diffusa. Struttura in ottone brunito chiaro o scuro con paralumi in metallo microforato color oro opaco o nero opaco. Diffusori in vetro soffiato di Murano color bianco.

P. 24

3×MAX 33W G9 halogen 460lm 2700°K
or 3×4,5W G9 LED 350lm 2700°K

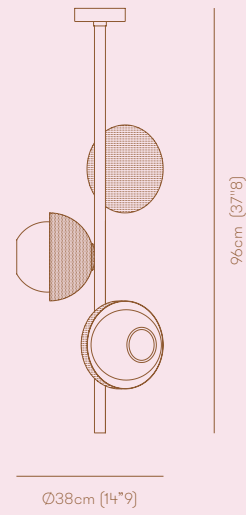

URBAN WALL TURNING ARM

Adjustable wall lamp with diffused light. Light or dark burnished brass structure with matte gold or matte black perforated metal lampshade. White Murano blown glass diffuser.

Lampada da parete con braccio orientabile a luce diffusa. Struttura in ottone brunito chiaro o scuro con paralume in metallo microforato color oro opaco o nero opaco. Diffusore in vetro soffiato di Murano color bianco.

P. 26

1×MAX 33W G9 halogen 460lm 2700°K
or 1×4,5W G9 LED 350lm 2700°K

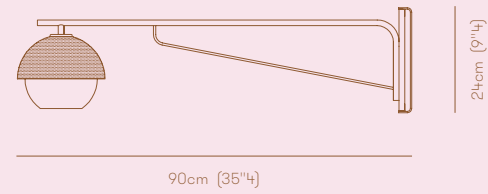

URBAN TABLE

Table lamp with diffused light. Light or dark burnished brass structure with matte gold or matte black perforated metal lampshade. White Murano blown glass diffuser.

Lampada da tavolo a luce diffusa. Struttura in ottone brunito chiaro o scuro con paralume in metallo microforato color oro opaco o nero opaco. Diffusore in vetro soffiato di Murano color bianco.

P. 30

1×MAX 33W G9 halogen 460lm 2700°K
or 1×4,5W G9 LED 350lm 2700°K

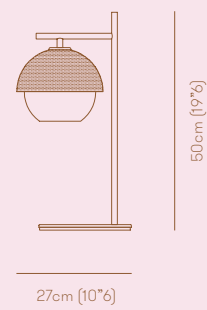

URBAN FLOOR 1

Floor lamp with diffused light. Light or dark burnished brass structure with matte gold or matte black perforated metal lampshade. White Murano blown glass diffuser.

Lampada da terra a luce diffusa. Struttura in ottone brunito chiaro o scuro con paralume in metallo microforato color oro opaco o nero opaco. Diffusore in vetro soffiato di Murano color bianco.

P. 20

1×MAX 33W G9 halogen 460lm 2700°K
or 1×4,5W G9 LED 350lm 2700°K

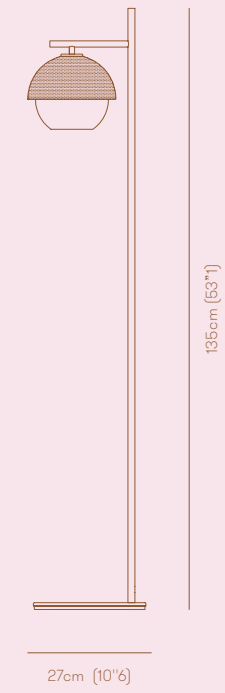

URBAN FLOOR 3

Floor lamp with diffused light. Light or dark burnished brass structure with matte gold or matte black perforated metal lampshades. White Murano blown glass diffusers.

Lampada da terra a luce diffusa. Struttura in ottone brunito chiaro o scuro con paralumi in metallo microforato color oro opaco o nero opaco. Diffusori in vetro soffiato di Murano color bianco.

P. 16

3×MAX 33W G9 halogen 460lm 2700°K
or 3×4,5W G9 LED 350lm 2700°K

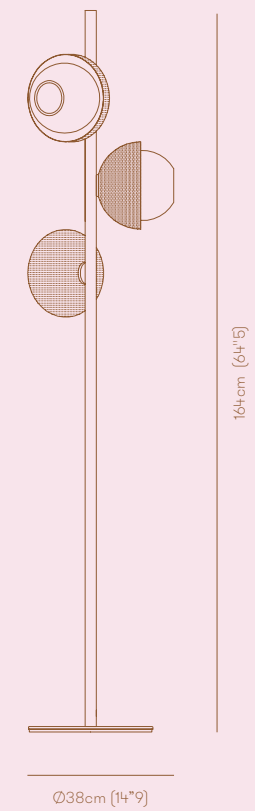

ZOE FLOOR

Floor lamp with diffused light.
Polished black nickel, polished gold,
polished chrome or light burnished
brass structure and white Murano
blown glass diffusers. Polished black
nickel, polished gold, polished chrome
or polished copper metal spheres.

Lampada da terra a luce diffusa.
Struttura in nichel nero lucido, oro
lucido, cromo lucido od ottone
brunito chiaro e diffusori in vetro
soffiato di Murano color bianco. Sfere
di metallo in nichel nero lucido, oro
lucido, cromo lucido o rame lucido.

P. 94

3×MAX 33W G9 halogen 460lm 2700°K
or 3×4,5W G9 LED 350lm 2700°K

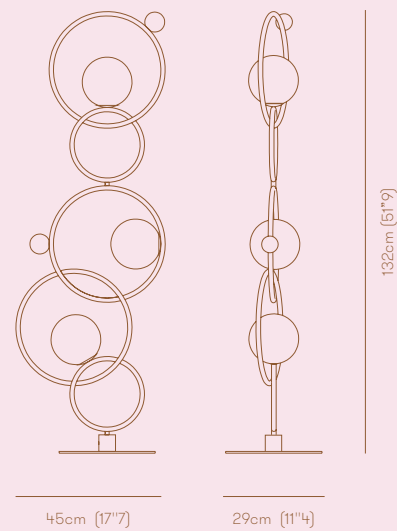

ZOE TABLE

Table lamp with diffused light.
Polished black nickel, polished gold,
polished chrome or light burnished
brass structure and white Murano
blown glass diffuser. Polished black
nickel, polished gold, polished chrome
or polished copper metal sphere.

Lampada da tavolo a luce diffusa.
Struttura in nichel nero lucido, oro
lucido, cromo lucido od ottone
brunito chiaro e diffusore in vetro
soffiato di Murano color bianco. Sfera
di metallo in nichel nero lucido, oro
lucido, cromo lucido o rame lucido.

P. 96

1×MAX 33W G9 halogen 460lm 2700°K
or 1×4,5W G9 LED 350lm 2700°K

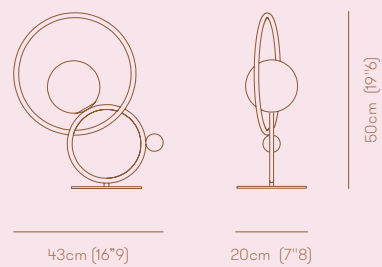

ZOE WALL

Wall lamp with diffused light. Polished
black nickel, polished gold, polished
chrome or light burnished brass
structure and white Murano blown
glass diffuser. Polished black nickel,
polished gold, polished chrome or
polished copper metal sphere.

Lampada da parete a luce diffusa.
Struttura in nichel nero lucido, oro
lucido, cromo lucido od ottone
brunito chiaro e diffusore in vetro
soffiato di Murano color bianco. Sfera
di metallo in nichel nero lucido, oro
lucido, cromo lucido o rame lucido.

1×MAX 33W G9 halogen 460lm 2700°K
or 1×4,5W G9 LED 350lm 2700°K

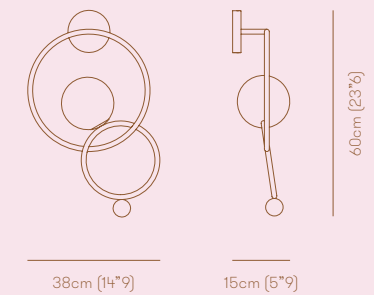

Concept & Graphic Design

Ottone Studio

Photographer

Federico Marin

Selection & Post Productions

Z13 Verona

Print

Grafiche Antiga

Edition 2017

VeniceM si riserva il diritto di apportare, senza preavviso, ogni modifica mirata al miglioramento funzionale e qualitativo dei prodotti. Testi e disegni presenti in questo stampato hanno scopo divulgativo; per ogni aspetto tecnico e dimensionale fare riferimento ai listini aziendali e relativi aggiornamenti. I campioni di colore e materiali hanno valore indicativo.

VeniceM reserves the rights at all time to apply modifications for the functional or qualitative improvement of its products. Texts and drawings present in this brochure have a divulgative purpose: for every technical and dimensional aspect please refer to the company's price lists and their relative updates. The colour and material samples have an indicative value.

© VeniceM - Tutti i diritti sono riservati a norma di legge / All rights reserved
Il marchio VeniceM è proprietà della VeniceM srl / Trade Mark VeniceM

VENICEM S.R.L.

via Terraglio, 17, interno 3
31021 Mogliano Veneto (TV)
Italy

T / F (+39) 041 593 6143
info@venicem.com
www.venicem.com

MADE IN ITALY

VENICEM.COM