

**KLUŚ**® Inspiring  
Solutions

CREATIVE LED SOLUTIONS *get inspired*

**PRZEGLĄD PROFILI KLUŚ**  
**KLUŚ PROFILES OVERVIEW**



Trzonem działania firmy  
był zawsze **Design**

Stawiamy sobie za cel dostarczanie dopracowanych rozwiązań dla oświetlenia LED, które pobudzają kreatywność projektanta oraz "ułatwiają życie" specjalistom branżowym. Staramy się inspirować projektantów do tworzenia innowacyjnych, funkcjonalnych i pięknych projektów oświetlenia.

**Design** has always been at the core  
of our business

We inspire designers to create innovative, functional and beautiful lighting designs. Our goal is to design products that significantly „make life easier” for contractors and industry specialists.

<b>PROFILE DO LED LED PROFILES</b> .....	<b>4</b>
Uniwersalne: wbudowane   Universal: recessed .....	4
Uniwersalne: zwieszane / montaż na powierzchni   Universal: suspension / surface mounting .....	5
Uniwersalne: kątowe   Universal: angular .....	9
Minimalistyczne: wbudowane   Minimalistic: recessed .....	11
Minimalistyczne: zwieszane / montaż na powierzchni   Minimalistic : suspension / surface mounting .....	12
Architektoniczne: wbudowane   Architectural: recessed .....	13
Architektoniczne: zwieszane / montaż na powierzchni   Architectural: suspension / surface mounting .....	18
Architektoniczne: kątowe   Architectural: angular .....	24
Do oświetlenia ogólnego: wbudowane   For main lighting: recessed .....	25
Do oświetlenia ogólnego: zwieszane / montaż na powierzchni   For main lighting: suspension / surface mounting .....	27
Zastosowania specjalne: podświetlenie nisz   Special applications: illumination of coves and architectural niches .....	29
Zastosowania specjalne: sufity napinane   Special applications: installation and illumination of stretch ceilings .....	31
Zastosowania specjalne: budowa kinkietów   Special applications: for sconce and wall lighting .....	33
Zastosowania specjalne: podświetlenie przezroczystych paneli   Special applications: transparent panel illumination .....	36
Zastosowania specjalne: podświetlenie schodów   Special applications: stair illumination .....	38
Zastosowania specjalne: podłogowe   Special applications: for floors .....	39
Zastosowania specjalne: fasadowe   facade .....	41
Profile techniczne: wbudowane   Mounting tracks: recessed .....	45
Profile techniczne: zwieszane / montaż na powierzchni   Mounting tracks: suspension / surface mounting .....	50
<b>OSŁONY DO PROFILI COVERS FOR PROFILES</b> .....	<b>54</b>

## Oznaczenia profili: / Profile markings:

**NEW!**

- Profile wprowadzone do oferty w ciągu ostatnich 12 miesięcy
- Profiles introduced to the offer in the last 12 months

**TOP SELLER!**

- Profile popularne wśród klientów firmy KLUŚ i jej dystrybutorów
- Profiles popular with KLUŚ customers and distributors

**ECO**

- Profile ekonomiczne o uproszczonej konstrukcji, głównie do zastosowań meblowych
- Economical profiles with a simplified structure, mainly for furniture applications



- Profile dostosowane do norm budowlanych na rynku USA, (płyty g-k o grubości 16 mm)
- Profiles adapted to construction standards on the US market, (drywall with a thickness of 16 mm)



min. 150 / 150 mm

- Profile z możliwością gięcia (promień minimalny dla giętej oprawy świecącej na zewnątrz / do wewnątrz, wyrażony w milimetrach)
- Bendable profiles (minimum radius for a bent lighting fixture directing light outwards / inwards, expressed in millimeters)



- Profile z możliwością "twistowania"
- Profiles with the possibility of "twisting"



- Możliwość łatwego łączenia w ciągi
- Can be easily connected into runs

## Dostępne wykończenia i wersje kolorystyczne: / Available finish and color options:



- srebrny, nieanodowany | silver, non-anodized



- srebrny, anodowany | silver, anodized



- czarny, anodowany lub lakierowany | black, anodized or lacquered



- biały lakierowany | white, lacquered

**Instrukcje montażu profili oraz systemów przedstawionych poniżej dostępne są na [www.KlusDesign.pl](http://www.KlusDesign.pl)**

**Mounting instructions for the profiles and systems presented below available on [www.KlusDesign.eu](http://www.KlusDesign.eu)**



# PROFILE DO LED LED PROFILES

Uniwersalne

Universal



## MICRO-NK (Ref. A01587A)

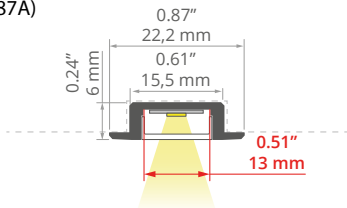

Oslony / Covers  
mleczne / frosted: B17035M,  
B17064M, B17208M, B17121M,  
B17037M, B17179M  
przeźroczyste / transparent: B17035T,  
B17208T, B17122T, B17064T  
czarne / black: B17037C

Zaślepki / End caps:  
C24346L01, C24427L10,  
C24346C02, C24427C02,  
C24346C07, C24427C07,  
C24346C10, C24427C10,  
C24427C07TW, C24346C02TW,  
C24427C02TW, C24346C07TW,  
C24346C10TW, C24346L01TW,  
C24427C10TW, C24427L10TW

## PDS-NK (Ref. A01588A)

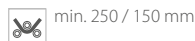

**TOP SELLER!**

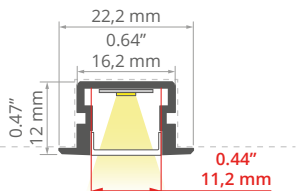

Oslony / Covers  
mleczne / frosted: B17035M,  
B17064M, B17208M, B17121M,  
B17037M, B17179M  
przeźroczyste / transparent: B17035T,  
B17208T, B17122T, B17064T  
czarne / black: B17037C

Zaślepki / End caps:  
C24338L01, C24428L01,  
C24338C02, C24428C02,  
C24338C07, C24428C07,  
C24338C10, C24428C10,  
C24338C07TW, C24428C07TW,  
C24338C02TW, C24428C02TW,  
C24338L01TW, C24338C10TW,  
C24428C10TW, C24428L01TW

## TAKO (Ref. A05392A)



**ECO**

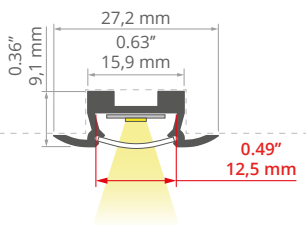

Oslony / Covers  
mleczne / frosted: B17009M

Zaślepki / End caps:  
C20053C10

Uniwersalne

Universal



**MICRO-PLUS** (Ref. A02966)

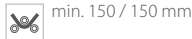

**TOP SELLER!**

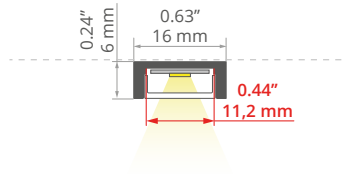

Oslony / Covers  
 mleczne / frosted: B17035M,  
 B17038M, B17064M, B17208M,  
 B17121M, B17037M, B17179M  
 przezroczyste / transparent: B17035T,  
 B17208T, B17122T, B17064T  
 czarne / black: B17037C

Zaślepki / End caps:  
 C20123L01, C20123C02,  
 C24216C02, C20123C07,  
 C20123C10, C20123C10TW,  
 C20123C07TW, C20123C02TW,  
 00024, C20101C10TW,  
 C20101C07TW, C28202N00

**MICRO-H** (Ref. A00599A)

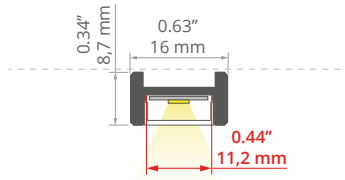

Oslony / Covers  
 mleczne / frosted: B17035M,  
 B17064M, B17208M, B17121M,  
 B17037M, B17179M  
 przezroczyste / transparent: B17035T,  
 B17208T, B17122T, B17064T  
 czarne / black: B17037C

Zaślepki / End caps:  
 C24261C02

**MICRO-HG** (Ref. A01419A)

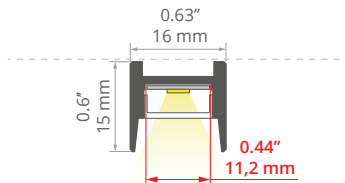

Oslony / Covers  
 mleczne / frosted: B17035M,  
 B17064M, B17208M, B17121M,  
 B17037M, B17179M  
 przezroczyste / transparent: B17035T,  
 B17208T, B17122T, B17064T  
 czarne / black: B17037C

Zaślepki / End caps:  
 C24261C02

**PDS-H** (Ref. A09204A)

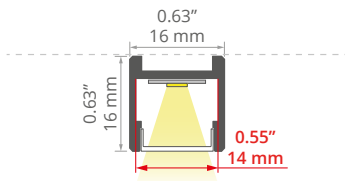

Oslony / Covers  
 mleczne / frosted: B17035M,  
 B17064M, B17208M, B17121M,  
 B17037M, B17179M  
 przezroczyste / transparent: B17035T,  
 B17208T, B17122T, B17064T  
 czarne / black: B17037C

Zaślepki / End caps:  
 C24145L01, C24145C02

**PDS-4-PLUS** (Ref. A01263A)

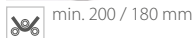

TOP SELLER!

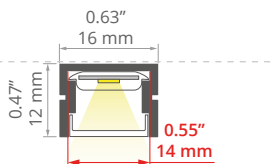

Oslony / Covers  
 mleczne / frosted: B17035M,  
 B17064M, B17208M, B17121M,  
 B17037M, B17076M, B17179M  
 przezroczyste / transparent: B17035T,  
 B17208T, B17122T, B17064T,  
 B17112T  
 czarne / black: B17037C

Zaślepki / End caps:  
 C24145L01, C24145C02

**PDS-ZM-PLUS** (Ref. A02056A)

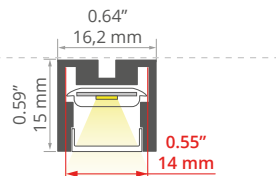
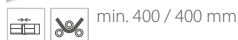
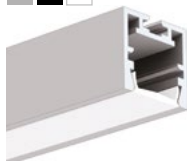

Oslony / Covers  
 mleczne / frosted: B17035M,  
 B17064M, B17208M, B17121M,  
 B17037M, B17076M, B17179M  
 przezroczyste / transparent: B17035T,  
 B17208T, B17122T, B17064T,  
 B17112T  
 czarne / black: B17037C

Zaślepki / End caps:  
 C24364C02, C24364C07, C24364C10

**PDS-ZMG** (Ref. A01418A07)

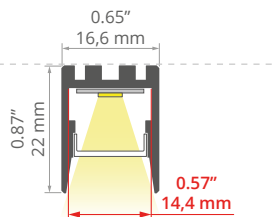

Oslony / Covers  
 mleczne / frosted: B17035M,  
 B17064M, B17208M, B17121M,  
 B17037M, B17179M  
 przezroczyste / transparent: B17035T,  
 B17208T, B17122T, B17064T  
 czarne / black: B17037C

Zaślepki / End caps:  
 C24330C02, C24320C07

**OLEK** (Ref. A08505A)

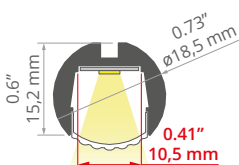

Oslony / Covers  
 mleczne / frosted: B17035M,  
 B17064M, B17208M, B17121M,  
 B17037M, B17076M, B17179M  
 przezroczyste / transparent: B17035T,  
 B17208T, B17122T, B17064T,  
 B17112T  
 czarne / black: B17037C

Zaślepki / End caps:  
 C24203C02, C24204C02,  
 C24204C07, C24203C07,  
 C24204C10, C24203C10,  
 C24204C02TW, C28213C02,  
 C28212C02, C28221AS



**STOS-ALU** (Ref. A04369A)



min. 250 / 200 mm

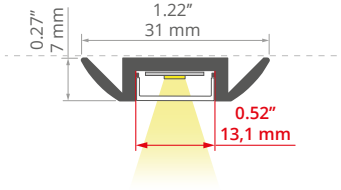

Oslony / Covers  
mleczne / frosted: B17201M,  
B17078M, B17066M  
przeźroczyste / transparent: B17201T,  
B17078T, B17066T

Zasłepki / End caps:  
C20108L01, C20108C02

**SILER** (Ref. A09325A)



min. 250 / 400 mm

**TOP SELLER!**

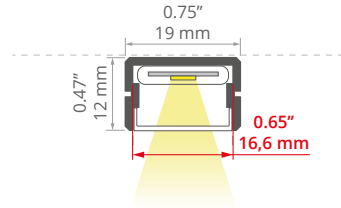

Oslony / Covers  
mleczne / frosted: B17039M  
przeźroczyste / transparent: B17039T

Zasłepki / End caps:  
C24236C02, C24236C07,  
C24236C10, C28222AS

**TAMI** (Ref. A05390N)



**ECO**

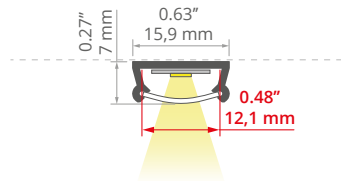

Oslony / Covers  
mleczne / frosted: B17009M

Zasłepki / End caps:  
C20051C10

**TAPO** (Ref. A01919A)

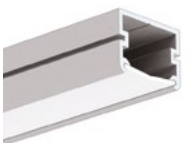

**ECO**

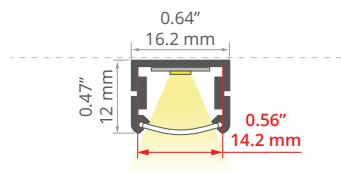

Oslony / Covers  
mleczne / frosted: B17009M

Zasłepki / End caps:  
C20055C10

**TOST** (Ref. A05393A)



**ECO**

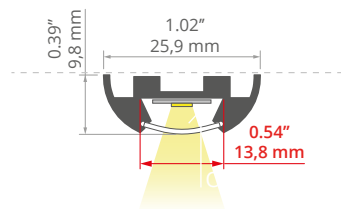

Oslony / Covers  
mleczne / frosted: B17009M

Zasłepki / End caps:  
C20054C10

MICRO-HG





Uniwersalne  
Universal

**45-ALU** (Ref. A04023N)



TOP SELLER!

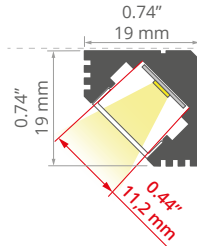

Oslony / Covers  
mleczne / frosted: B17035M,  
B17064M, B17208M, B17121M,  
B17037M, B17179M  
przeźroczyste / transparent: B17035T,  
B17208T, B17122T, B17064T  
czarne / black: B17037C

Zaślepki / End caps:  
C20124C02, C20124C07,  
C20124C10, C20124C10TW,  
C20124C07TW, C20124C02TW,  
C20105C10TW, 00031,  
C20105C07TW, C20105C10,  
C20105C02

**KUBIK-45** (Ref. A07697A)

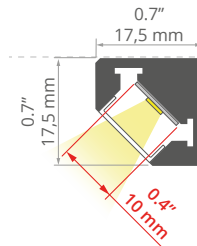

Oslony / Covers  
mleczne / frosted: B17035M,  
B17064M, B17208M, B17121M,  
B17037M, B17076M, B17179M  
przeźroczyste / transparent: B17035T,  
B17208T, B17122T, B17064T  
czarne / black: B17037C

**PAC-ALU** (Ref. A04370A)

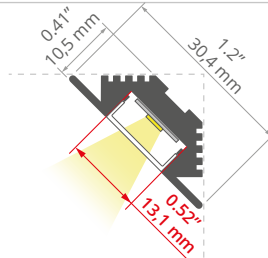

Oslony / Covers  
mleczne / frosted: B17201M,  
B17078M, B17066M  
przeźroczyste / transparent: B17201T,  
B17078T, B17066T

Zaślepki / End caps:  
C24206C02

**TAN-C5** (Ref. A05391A)



ECO

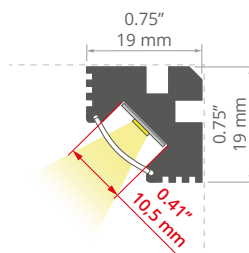

Oslony / Covers  
mleczne / frosted: B17009M

Zaślepki / End caps:  
C20052C10

**45-16** (Ref. A08504A)

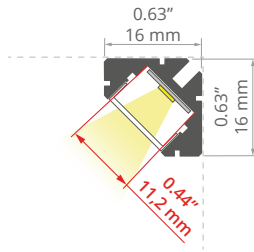

Oslony / Covers  
mleczne / frosted: B17035M,  
B17064M, B17208M, B17121M,  
B17037M, B17179M  
przeźroczyste / transparent: B17035T,  
B17208T, B17122T, B17064T  
czarne / black: B17037C

Zaślepki / End caps:  
C24206C02



Minimalistyczne

Minimalistic



**KOZEL-10** (Ref. A01575N)



TOP SELLER!

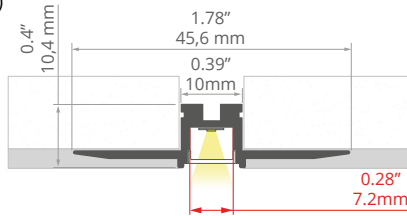

Oslony / Covers  
mleczne / frosted: B17034M

Zaslepki / End caps:  
C24307C02, C24307C07,  
C24307C07TW, C24307C02TW



Minimalistyczne  
Minimalistic



**PIKO** (Ref. A08288A)



TOP SELLER!

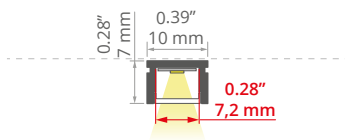

Oslony / Covers  
mleczne / frosted: B17034M

Zaślepki / End caps:  
C24202C02, C24202C02TW,  
C24202C07, C24202C07TW

**PIKO-O** (Ref. A01167A)

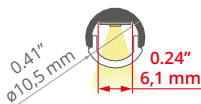

Oslony / Covers  
mleczne / frosted: B17164M  
mroźone / semi-transparent:  
B17064F  
czarne / black: B17064C

Zaślepki / End caps:  
C24321C02, C24321C07,  
C24369C7015, C24321C10,  
C24321C07TW, C24321C02TW,  
C24321C10TW, C28223C7012

**PIKO-ZM** (Ref. A01168A)

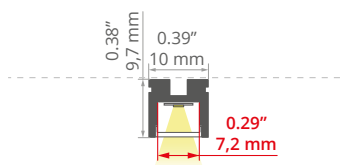

Oslony / Covers  
mleczne / frosted: B17069M,  
B17034M

Zaślepki / End caps:  
C24307C02, C24307C07,  
C24307C07TW, C24307C02TW





Architektoniczne  
Architectural

**PDS-T** (Ref. A02057N)

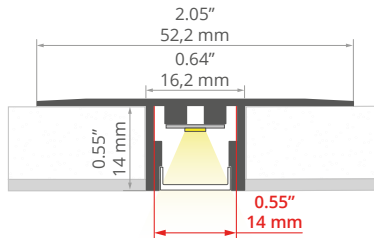

Oslony / Covers  
mleczne / frosted: B17035M,  
B17064M, B17208M, B17121M,  
B17037M, B17179M  
przeźroczyste / transparent: B17035T,  
B17208T, B17122T, B17064T,  
B17112T  
czarne / black: B17037C

Zaśleпки / End caps:  
C24364C02, C24364C10

**PDS-UST** (Ref. A02725N)

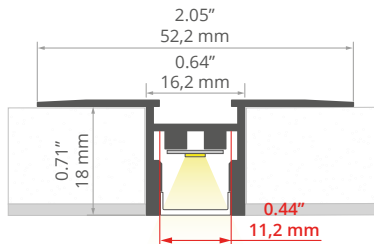
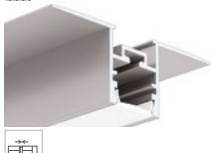

Oslony / Covers  
mleczne / frosted: B17035M,  
B17064M, B17208M, B17121M,  
B17037M, B17179M  
przeźroczyste / transparent: B17035T,  
B17208T, B17122T, B17064T,  
B17112T  
czarne / black: B17037C

Zaśleпки / End caps:  
C24364C02, C24364C10

**KOZMA** (Ref. A18040N)

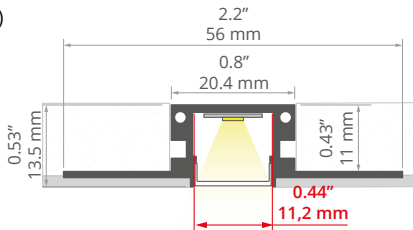

Oslony / Covers  
mleczne / frosted: B17035M,  
B17064M, B17208M, B17121M,  
B17037M, B17179M  
przeźroczyste / transparent: B17035T,  
B17208T, B17122T, B17064T  
czarne / black: B17037C

Zaśleпки / End caps:  
C24217C02

**GIZA-LL-T** (Ref. A02479N)

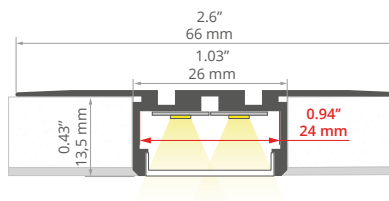

Oslony / Covers  
mleczne / frosted: B17032M,  
B17011M, B17203M, B17013M,  
B17006M  
mrożone / semi-transparent:  
B17042F, B17204F  
przeźroczyste / transparent: B17006T,  
B17011T, B17173  
czarne / black: B17032C, B17013C,  
B17006C

Zaśleпки / End caps:  
C24281C02, C24281C07, C24281C10

**GIZA-LL-UST** (Ref. A02724N)

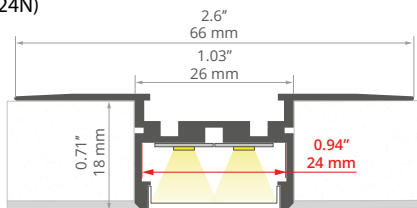
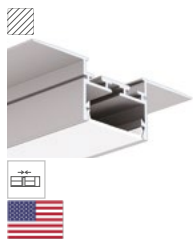

Oslony / Covers  
mleczne / frosted:  
B17032M, B17011M, B17203M,  
B17013M, B17006M  
mroźone / semi-transparent:  
B17042F, B17204F  
przeźroczyste / transparent:  
B17006T, B17011T, B17173  
czarne / black:  
B17032C, B17013C, B17006C

Zaślepki / End caps:  
C24281C02, C24281C07, C24281C10

**KOZEL** (Ref. A06454N)

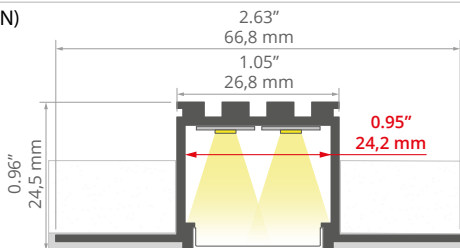

Oslony / Covers  
mleczne / frosted:  
B17032M, B17011M, B17203M,  
B17013M, B17006M  
mroźone / semi-transparent:  
B17042F, B17204F  
przeźroczyste / transparent:  
B17006T, B17011T  
czarne / black: B17032C, B17013C,  
B17006C

Zaślepki / End caps:  
C24034C02

**KOZUS** (Ref. A07823N)

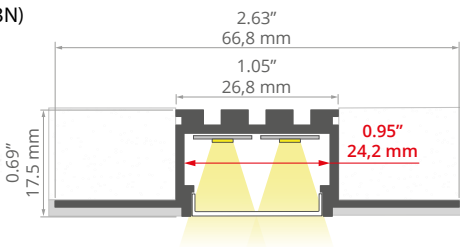
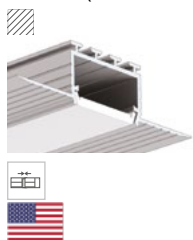

Oslony / Covers  
mleczne / frosted:  
B17032M, B17011M, B17203M,  
B17013M, B17006M  
mroźone / semi-transparent:  
B17042F, B17204F  
przeźroczyste / transparent:  
B17006T, B17011T  
czarne / black: B17032C, B17013C,  
B17006C

Zaślepki / End caps:  
C24148C02

**KOZUS-CR** (Ref. A00600N)

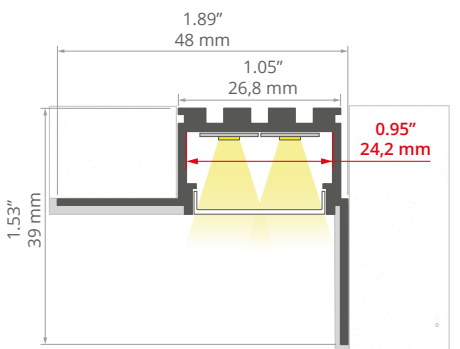

Oslony / Covers  
mleczne / frosted:  
B17032M, B17011M, B17203M,  
B17013M, B17006M  
mroźone / semi-transparent:  
B17042F, B17204F  
przeźroczyste / transparent:  
B17006T, B17011T  
czarne / black:  
B17032C, B17013C, B17006C

Zaślepki / End caps:  
C24148C02



**LARKO** (Ref. A05552A)

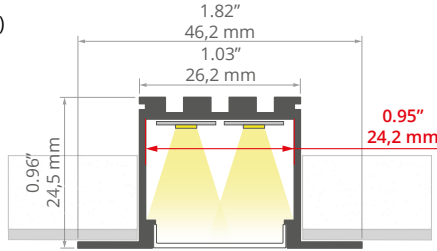

Oslony / Covers  
 mleczne / frosted:  
 B17032M, B17011M, B17203M,  
 B17013M, B17006M  
 mroźone / semi-transparent:  
 B17042F, B17204F  
 przeźroczyste / transparent:  
 B17006T, B17011T  
 czarne / black:  
 B17032C, B17013C, B17006C

Zaśleпки / End caps:  
 C24281C02, C24281C07, C24281C10

**LOKOM** (Ref. A05553A)



min. 3000 / 3000 mm

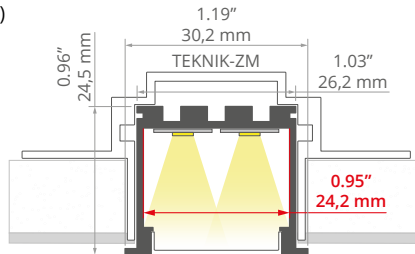

Oslony / Covers  
 mleczne / frosted:  
 B17032M, B17011M, B17203M,  
 B17013M, B17006M  
 mroźone / semi-transparent:  
 B17042F, B17204F  
 przeźroczyste / transparent:  
 B17006T, B17011T,  
 czarne / black:  
 B17032C, B17013C, B17006C

Zaśleпки / End caps:  
 C24005L01, C24005C02, C24005C07

**OPAC-30** (Ref. A06164A)

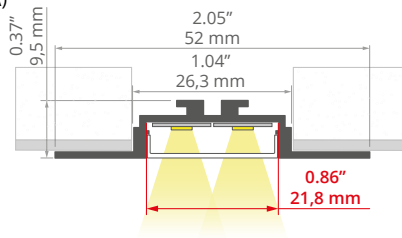

Oslony / Covers  
 mleczne / frosted:  
 B17032M, B17011M, B17203M,  
 B17013M, B17006M  
 mroźone / semi-transparent:  
 B17042F, B17204F  
 przeźroczyste / transparent:  
 B17006T, B17011T,  
 czarne / black:  
 B17032C, B17013C, B17006C

Zaśleпки / End caps:  
 C24045L01, C24045C02



**POKET** (Ref. A01179N)



**NEW!**

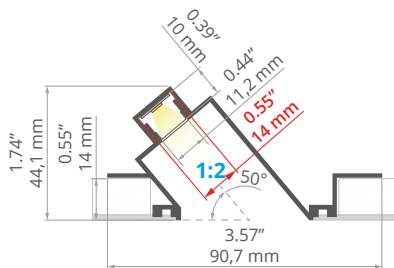

Oslony / Covers  
przeźroczyste / transparent: B17112T

Zaślepki / End caps:  
C24460C02, C24460C10

**DIPOKET** (Ref. A01177N)



**NEW!**

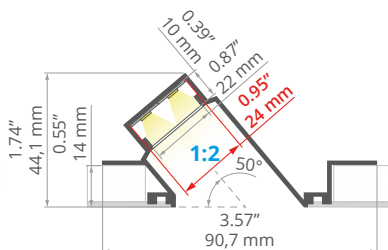

Oslony / Covers  
przeźroczyste / transparent: B17173

Zaślepki / End caps:  
C24461C02, C24461C02

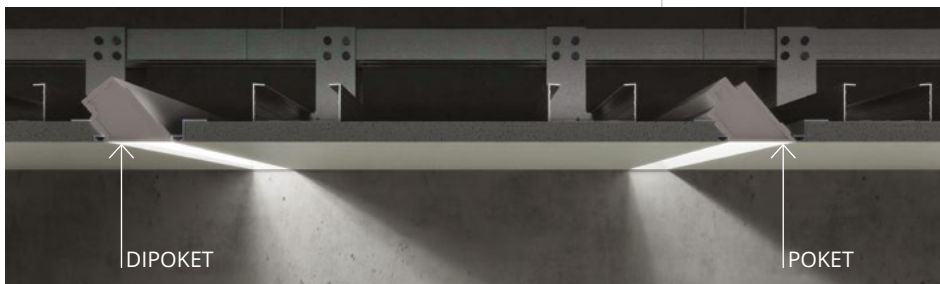

**POK-US** (Ref. A01234N)

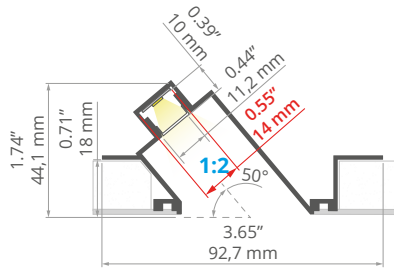

**NEW!**

Oslony / Covers  
przeźroczyste / transparent: B17112T

Zaślepki / End caps:  
C24460C02, C24460C10

**DIPOK-US** (Ref. A01233N)

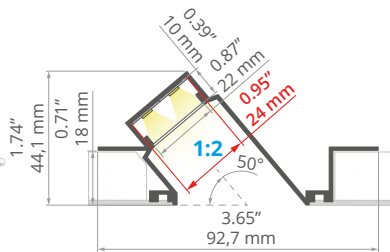

**NEW!**

Oslony / Covers  
przeźroczyste / transparent: B17173

Zaślepki / End caps:  
C24461C02, C24461C02





## Architektoniczne Architectural

### LIPOD (Ref. A05554A)



min. 3000 / 3000 mm

**TOP SELLER!**

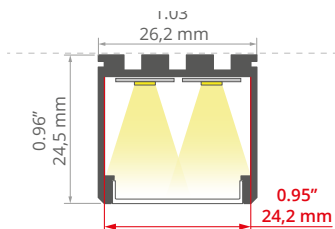

Oslony / Covers  
mleczne / frosted: B17032M,  
B17011M, B17203M, B17013M,  
B17006M  
mroźone / semi-transparent: B17042F,  
B17204F  
przeźroczyste / transparent: B17006T,  
B17011T,  
czarne / black: B17032C, B17013C,  
B17006C

Zaślepki / End caps:  
C24004L01, C24004C02,  
C24004C07, C24004C10

### 3035-O (Ref. A08441A)

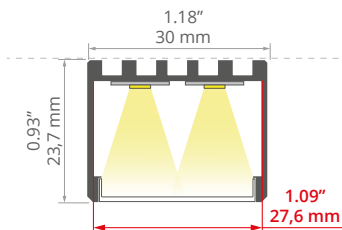

Oslony / Covers  
mleczne / frosted: B17141M

Zaślepki / End caps:  
C24274C02, C28217AS

### 3035 (Ref. A18039A)

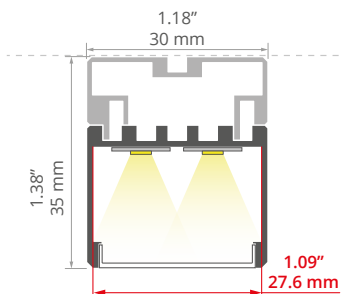

Oslony / Covers  
mleczne / frosted: B17141M

Zaślepki / End caps:  
C24273C02, C28216AS

**4050** (Ref. A18050A)

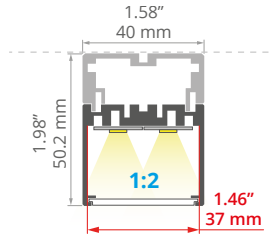

Oslony / Covers  
mleczne / frosted: B17057M  
przezroczyste / transparent:  
17055\_1.5

Zaśleпки / End caps:  
C28017C02

**4050-W** (Ref. A18051A)

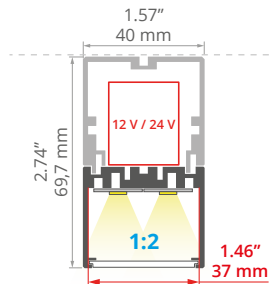

Oslony / Covers  
mleczne / frosted: B17057M  
przezroczyste / transparent:  
17055\_1.5

Zaśleпки / End caps:  
C28018C02

**JAZ** (Ref. A08547A)

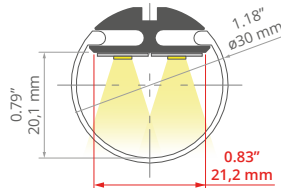

Oslony / Covers  
mleczne / frosted: B17162M

Zaśleпки / End caps:  
C24224C02, C28219AS

TOP SELLER!

**JAZ-DUO** (Ref. A00788A)

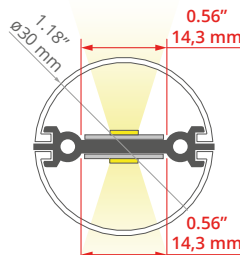
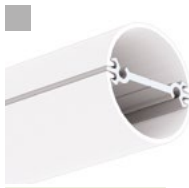

Oslony / Covers  
mleczne / frosted: B17163M

Zaśleпки / End caps:  
C28224C02, C28225C02,  
C28225L10, C28224C02TW,  
C28224C02TW6,5, C28224C02P,  
C28225C02P

TOP SELLER!

**GIZA** (Ref. A05556A)



 min. 200 / 200 mm

**TOP SELLER!**

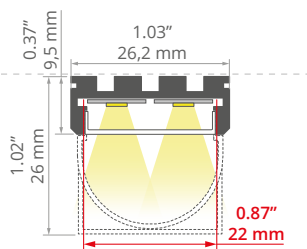

Oslony / Covers  
 mleczne / frosted: B17032M,  
 B17011M, B17203M, B17013M,  
 B17006M  
 mrozone/ semi-transparent: B17042F,  
 B17204F  
 przezroczyste / transparent: B17006T,  
 B17011T  
 czarne / black: B17032C, B17013C,  
 B17006C

Zaślepki / End caps:  
 C24029L01, C24030L01, C24007L01,  
 C24007C02, C24029C02, C24030C02

**GIZA-LL** (Ref. A00758A)



 min. 240 / 240 mm

**TOP SELLER!**

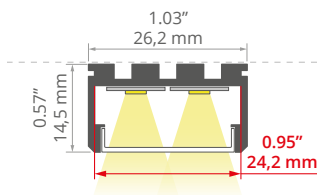

Oslony / Covers  
 mleczne / frosted: B17032M,  
 B17011M, B17203M, B17013M,  
 B17006M  
 mrozone/ semi-transparent: B17042F,  
 B17204F  
 przezroczyste / transparent: B17006T,  
 B17011T, A00758A, B17173  
 czarne / black: B17032C, B17013C,  
 B17006C

Zaślepki / End caps:  
 C24281C02, C24281C07, C24281C10

**GLAZA-LL** (Ref. A02627A)



 min. 240 / 240 mm

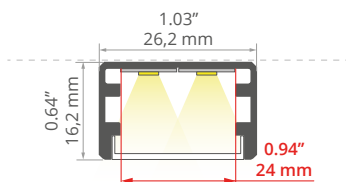

Oslony / Covers  
 mleczne / frosted: B17032M  
 mrozone/ semi-transparent: B17042F  
 przezroczyste / transparent: B17011T  
 czarne / black: B17032C

Zaślepki / End caps:  
 C24368C10, C24368C02, C24368C07

**GLAZA-DUO** (Ref. A03059A)





**NEW!**

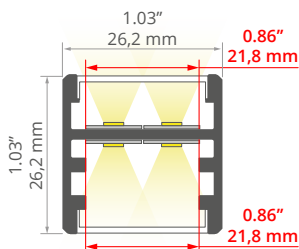

Oslony / Covers  
 mleczne / frosted: B17032M,  
 B17011M  
 mrozone/ semi-transparent: B17042F  
 przezroczyste / transparent: B17011T  
 czarne / black: B17032C

Zaślepki / End caps:  
 C24418L01, C24418C02

**GIZA-LL-ZMG** (Ref. A04501A)



**NEW!**

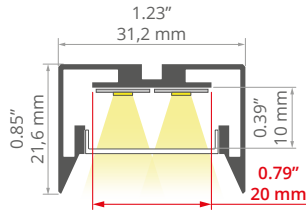

Osłony / Covers  
 mleczne / frosted: B17032M,  
 B17011M  
 mroźone / semi-transparent: B17042F  
 przezroczyste / transparent: B17011T,  
 B17173  
 czarne / black: B17032C

Zaślepki / End caps:  
 C24418L01, C24418C02

**GIZA-DUO-LL** (Ref. A02162A)



min. 240 / 240 mm

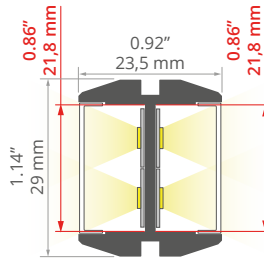

Osłony / Covers  
 mleczne / frosted: B17032M,  
 B17011M  
 mroźone / semi-transparent: B17042F  
 przezroczyste / transparent: B17011T  
 czarne / black: B17032C

Zaślepki / End caps:  
 C24372L01, C24372C02

**OPK-4** (Ref. A00370A)



min. 300 / 300 mm

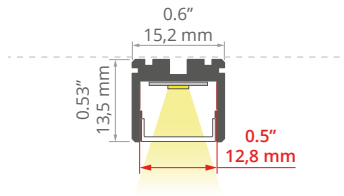

Osłony / Covers  
 mleczne / frosted: B17035M,  
 B17064M, B17208M, B17121M,  
 B17037M, B17179M  
 przezroczyste / transparent: B17035T,  
 B17208T, B17122T, B17064T  
 czarne / black: B17037C

Zaślepki / End caps:  
 C24238C02

**REGULOR** (Ref. A18068A)



**TOP SELLER!**

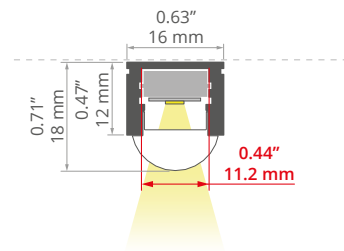

Osłony / Covers  
 przezroczyste / transparent: B17202T,  
 B17202S

Zaślepki / End caps:  
 C20116C02, C20116C02TW

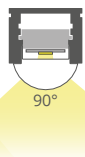
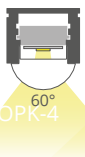
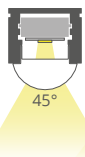
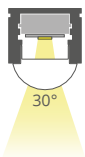
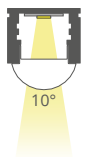

OPK-4







GIZA-DUO-LL

GIZA-DUO-LL

Architektoniczne  
Architectural



**KOPRO** (Ref. A06367A)

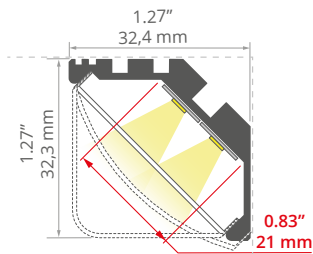
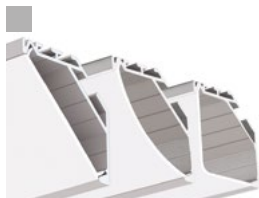

Oslony / Covers  
mleczne / frosted: B17093M,  
B17092M, B17091M

Zaślepki / End caps:  
C24116L01, C24115L01, C24117L01,  
C24115C02, C24116C02, C24117C02

**KOPRO-30** (Ref. A07890A)

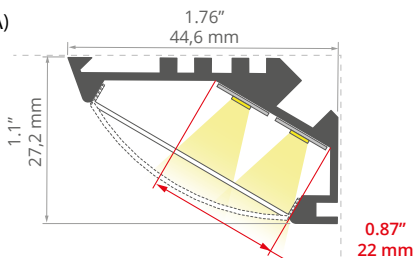
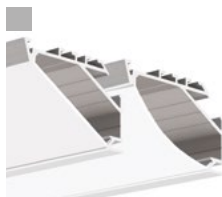

Oslony / Covers  
mleczne / frosted: B17092M,  
B17091M

Zaślepki / End caps:  
C24172L01, C24173L01, C24174L01,  
C24175L01, C24172C02,  
C24173C02, C24174C02, C24175C02

**LOC-30** (Ref. A18015A)

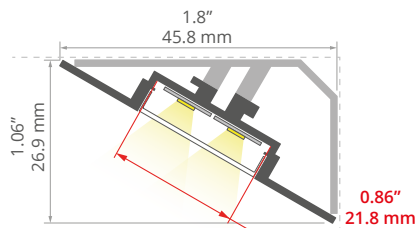
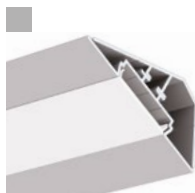

Oslony / Covers  
mleczne / frosted: B17032M,  
B17011M, B17203M, B17013M,  
B17006M  
mroźone/ semi-transparent: B17042F,  
B17204F, B17203M  
przeźroczyste / transparent: B17006T,  
B17011T  
czarne / black: B17032C, B17013C,  
B17006C

Zaślepki / End caps:  
C24022C02, C24023C02

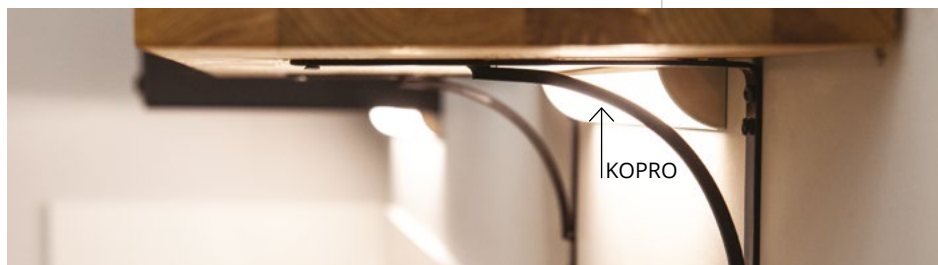



Do oświetlenia ogólnego  
For main lighting

**KOZEL-50** (Ref. A00757N)

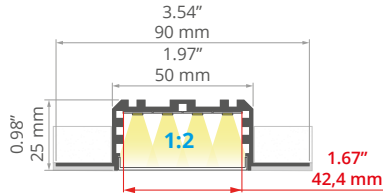

Oslony / Covers  
mleczne / frosted: B17086M  
czarne / black: B17086C

Zaśleпки / End caps:  
C24280C02

**KOZUS-50** (Ref. A00958N)

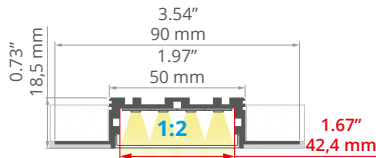
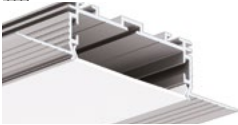

Oslony / Covers  
mleczne / frosted: B17086M  
czarne / black: B17086C

Zaśleпки / End caps:  
C24282C02

**LARKO-50** (Ref. A00756A)

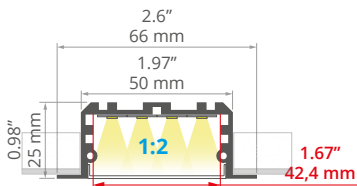

Oslony / Covers  
mleczne / frosted: B17086M  
czarne / black: B17086C

Zaśleпки / End caps:  
C28014C02

**SEKODU** (Ref. A06597A)

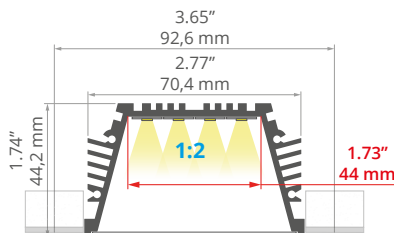

Oslony / Covers  
mleczne / frosted: B17081M, 17085,  
B17083M, B17084M  
przeźroczyste / transparent: B17081T

Zaśleпки / End caps:  
C28004L01, C28004C02

**SEKOMA** (Ref. A06595A)

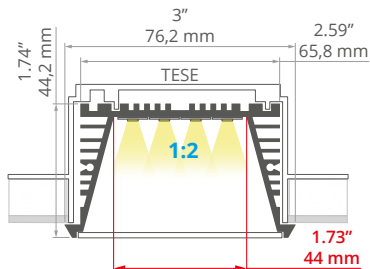

Oslony / Covers  
 mleczne / frosted: B17081M, 17085,  
 B17083M, B17084M  
 przezroczyste / transparent: B17081T

Zaślepki / End caps:  
 C28004L01, C28004C02

**OMODO-50** (Ref. A18053A)

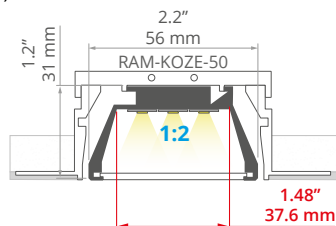

Oslony / Covers  
 mleczne / frosted: B17058M  
 przezroczyste / transparent:  
 17056\_1,5, B17169T

Zaślepki / End caps:  
 C28026C02

**OMODO-100** (Ref. A18058A)

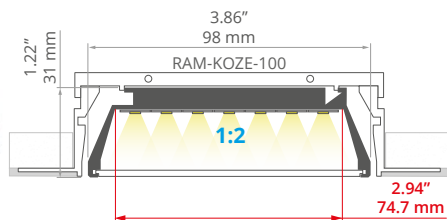

Oslony / Covers  
 mleczne / frosted: B17166M  
 przezroczyste / transparent:  
 17165\_1,5

Zaślepki / End caps:  
 C28027C02



OMODO-50 + RAM-KOL-50



Do oświetlenia ogólnego  
For main lighting

**LIPOD-50** (Ref. A02609A)



TOP SELLER!

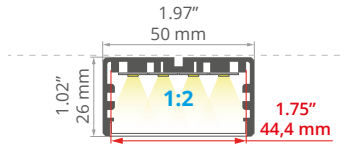

Osłony / Covers  
mleczne / frosted: B17086M  
czarne / black: B17086C

Zasłepki / End caps:  
C28028L01, C28028C02, C28028C07

**SEPOD** (Ref. A06593A)

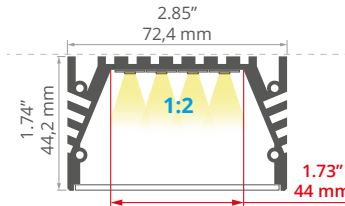
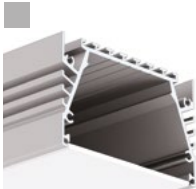

Osłony / Covers  
mleczne / frosted: B17081M, 17085,  
B17083M, B17084M  
przeźroczyste / transparent: B17081T

Zasłepki / End caps:  
C28003L01

**TRIADA** (Ref. A04476A)

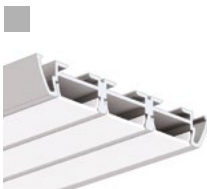

min. 200 / 200 mm

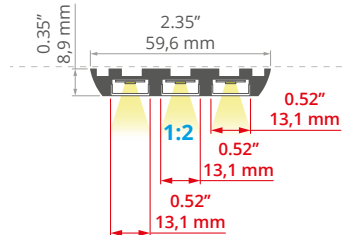

Osłony / Covers  
mleczne / frosted: B17201M,  
B17078M, B17066M  
przeźroczyste / transparent: B17201T,  
B17078T, B17066T

Zasłepki / End caps:  
C24056L01, C24056C02

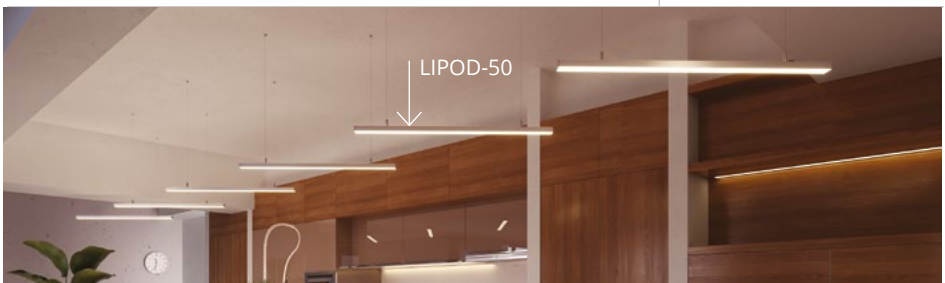

**DES** (Ref. A18030A)

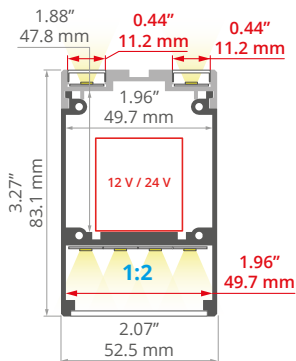

Oslony / Covers  
 mleczne / frosted: B17035M,  
 B17064M, B17052M, B17208M,  
 B17121M, B17037M  
 przezroczyste / transparent: B17035T,  
 B17052T, B17208T, B17122T,  
 B17064T  
 czarne / black: B17037C

Zaślepki / End caps:  
 C24151L01, C28209A01,  
 C24151C02, C28218AS

**GLADES** (Ref. A18036A)

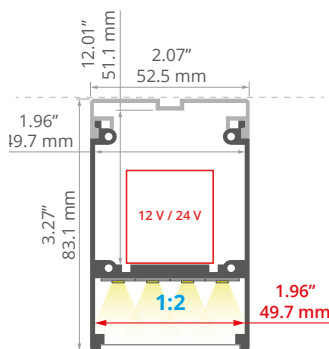
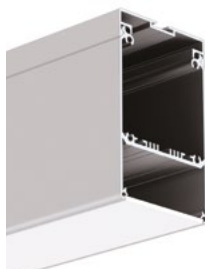

Oslony / Covers  
 mleczne / frosted: B17052M  
 przezroczyste / transparent: B17052T,  
 B17059P

Zaślepki / End caps:  
 C24151L01, C28209A01,  
 C24151C02, C28218AS

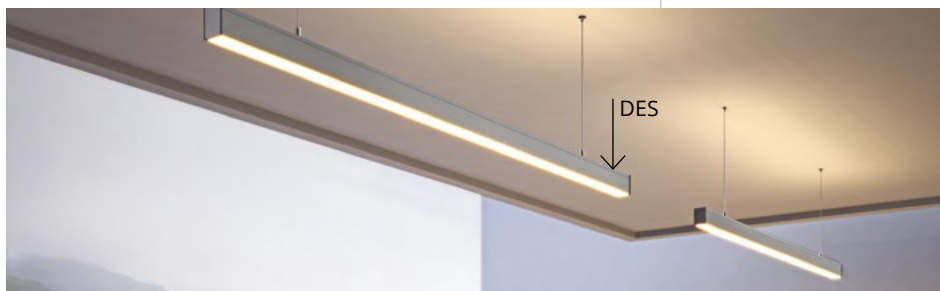



## Zastosowania specjalne: podświetlenie nisz

Special applications: illumination of covers and architectural niches

### NISA-KON (Ref. A18027N)

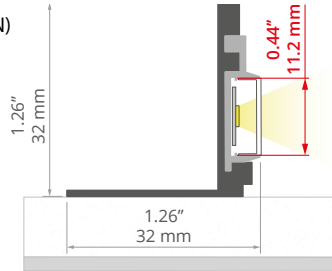

Osłony / Covers  
 mleczne / frosted: B17035M,  
 B17064M, B17208M, B17121M,  
 B17037M, B17179M  
 przezroczyste / transparent: B17035T,  
 B17208T, B17122T, B17064T

Zaślepki / End caps:  
 C24100C02

### NISA-NI (Ref. A18029N)

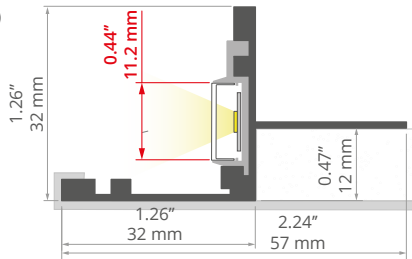
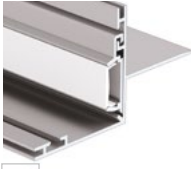

Osłony / Covers  
 mleczne / frosted: B17035M,  
 B17064M, B17208M, B17121M,  
 B17037M, B17179M  
 przezroczyste / transparent: B17035T,  
 B17208T, B17122T, B17064T

Zaślepki / End caps:  
 C24100C02

### NISA-KRA (Ref. A18026N)

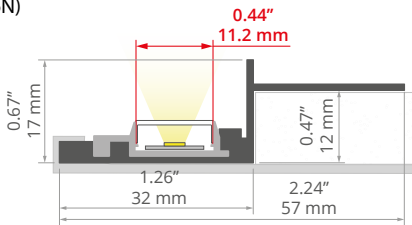

Osłony / Covers  
 mleczne / frosted: B17035M,  
 B17064M, B17208M, B17121M,  
 B17037M, B17179M  
 przezroczyste / transparent: B17035T,  
 B17208T, B17122T, B17064T

Zaślepki / End caps:  
 C24100C02

### POLI (Ref. A07176A)

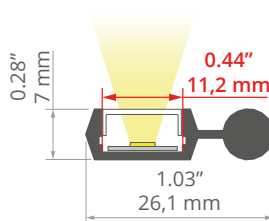

Osłony / Covers  
 mleczne / frosted: B17035M,  
 B17064M, B17208M, B17121M,  
 B17037M, B17179M  
 przezroczyste / transparent: B17035T,  
 B17208T, B17122T, B17064T  
 czarne / black: B17037C

Zaślepki / End caps:  
 C24128C02



POLI →





## Zastosowania specjalne: sufity napinane

Special applications: installation and illumination of stretch ceilings

### FOLED (Ref. A08332V1N)

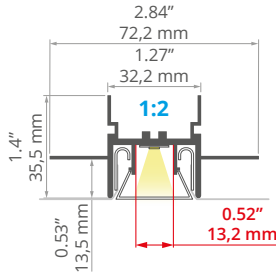

Oslony / Covers  
mleczne / frosted: B17045S, 17077V1  
czarne / black: B17045C

Zaśleпки / End caps:  
C28013C07, C24277C10,  
C28226N00

### FOLED-SUF (Ref. A08333V1N)

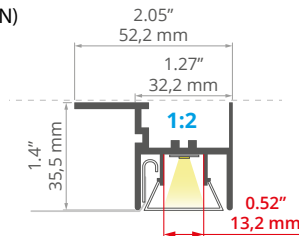

Oslony / Covers  
mleczne / frosted: B17045S, 17077V1  
czarne / black: B17045C

Zaśleпки / End caps:  
C28013C07, C24277C10,  
C28226N00

### FOLED-BOK (Ref. A08334V1N)

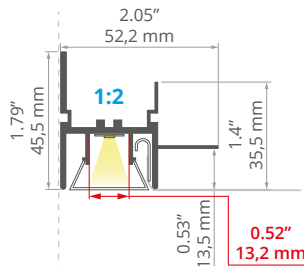

Oslony / Covers  
mleczne / frosted: B17045S, 17077V1  
czarne / black: B17045C

Zaśleпки / End caps:  
C28013C07, C24277C10,  
C28226N00

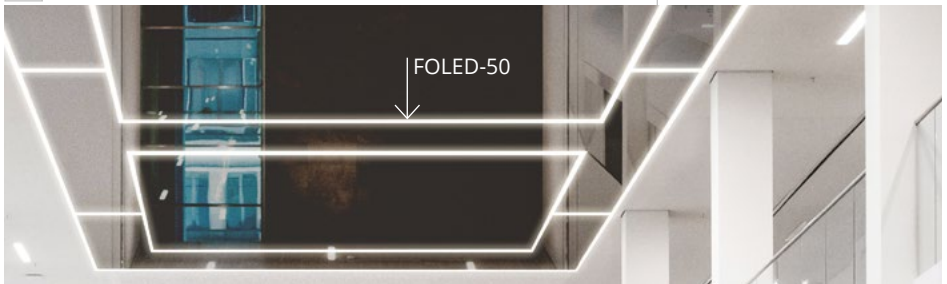

**FOLED-50** (Ref. A03632N)

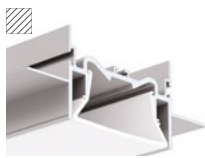

**NEW!**

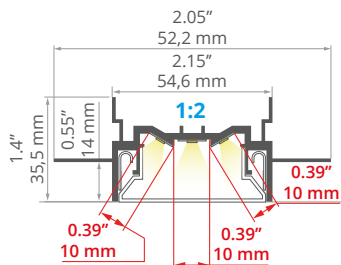

Oslony / Covers  
mleczne / frosted: B17171M  
czarne / black: B17045C

Zaślepki / End caps:  
C24294C02, C28238N00

**FOLED-50-SUF** (Ref. A03631N)



**NEW!**

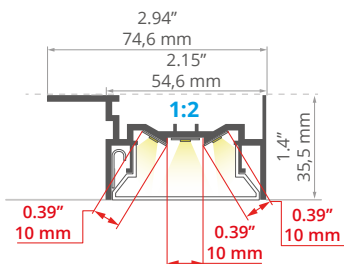

Oslony / Covers  
mleczne / frosted: B17171M  
czarne / black: B17045C

Zaślepki / End caps:  
C24294C02, C28238N00

**FOLED-50-BOK** (Ref. A0A57945N)

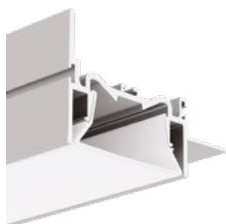

**NEW!**

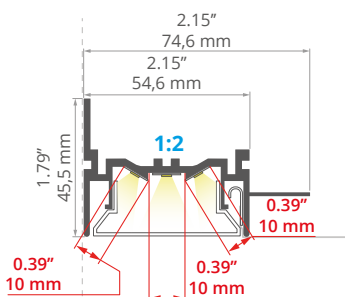

Oslony / Covers  
mleczne / frosted: B17171M  
czarne / black: B17045C

Zaślepki / End caps:  
C24294C02, C28238N00



Zastosowania specjalne: budowa kinkietów  
 Special applications: for sconce and wall lighting

**IKON** (Ref. A18013A)

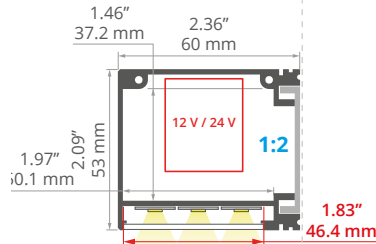

Oslony / Covers  
 mleczne / frosted: B17051M  
 przezroczyste / transparent: B17051T

Zaślepki / End caps:  
 C24013C02

**IMET** (Ref. A18012A)

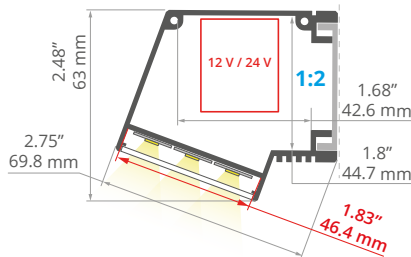
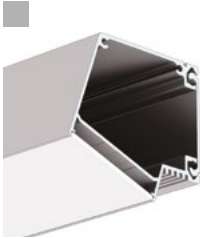

Oslony / Covers  
 mleczne / frosted: B17051M  
 przezroczyste / transparent: B17051T

Zaślepki / End caps:  
 C24016C02, C24017C02

**OBIT** (Ref. A04826A)

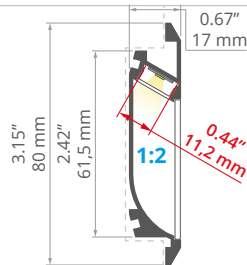

Oslony / Covers  
 mleczne / frosted: B17035M,  
 B17064M, B17052M, B17208M,  
 B17121M, B17037M  
 przezroczyste / transparent: B17035T,  
 B17052T, B17208T, B17122T,  
 B17064T

Zaślepki / End caps:  
 C24127L01, C24127C02



**LIT-L** (Ref. A18033N)

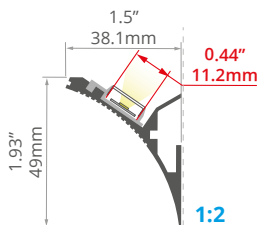

Oslony / Covers  
 mleczne / frosted: B17035M,  
 B17064M, B17208M, B17121M,  
 B17037M  
 przezroczyste / transparent: B17035T,  
 B17208T, B17122T, B17064T

Zaślepki / End caps:  
 C24100C02, C24180C10, C24181C10

**WERKIN** (Ref. A18025A)

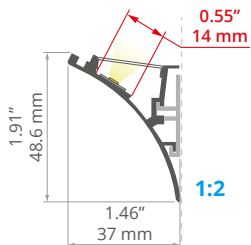

Oslony / Covers  
 mleczne / frosted: B17032M,  
 B17011M  
 mrożone / semi-transparent: B17042F  
 przezroczyste / transparent: B17011T  
 czarne / black: B17032C

Zaślepki / End caps:  
 C24140C02, C24141C02

**PLAKIN-DUO** (Ref. A04106)

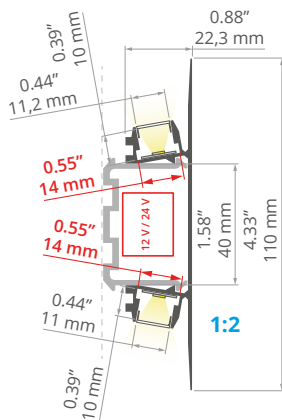

Oslony / Covers  
 mleczne / frosted: B17035M,  
 B17064M, B17208M, B17121M,  
 B17037M, B17179M  
 przezroczyste / transparent: B17035T,  
 B17208T, B17122T, B17064T  
 czarne / black: B17037C

Zaślepki / End caps:  
 C24469, C24470C02, C24470C07,  
 C24470C10

**NEW!**

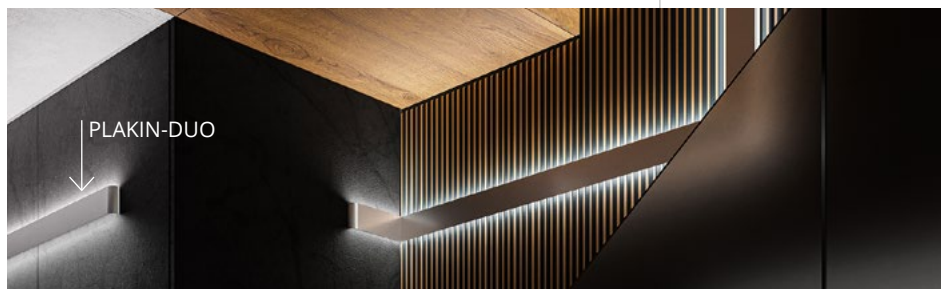

**KIDES** (Ref. A18031A)

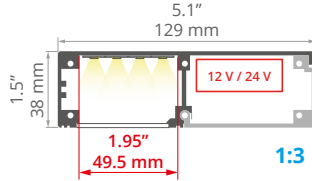

Oslony / Covers  
 mleczne / frosted: B17052M  
 przezroczyste / transparent: B17052T,  
 B17059P,

Zaślepki / End caps:  
 C28210A01, C24152L01, C28220A5

**KIDES-DUO** (Ref. A18032A)

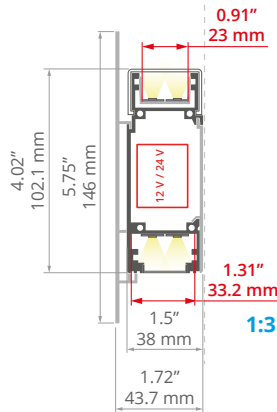

Oslony / Covers  
 mleczne / frosted: B17032M,  
 B17011M  
 mrożone / semi-transparent: B17042F,  
 B17131F  
 przezroczyste / transparent: B17011T  
 czarne / black: B17032C

Zaślepki / End caps:  
 C28211A01, C24153L01



## Zastosowania specjalne: podświetlenie przezroczystych paneli

## Special applications: transparent panel illumination



### **PULA** (Ref. A18035A)

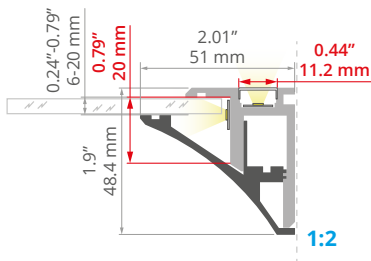

Oslony / Covers  
 mleczne / frosted: B17035M,  
 B17064M, B17208M, B17121M,  
 B17037M  
 przezroczyste / transparent: B17035T,  
 B17208T, B17122T, B17064T

Zaślepki / End caps:  
 C28008L01, C28009L01

### **KRAV-051N** (Ref. A18045A)

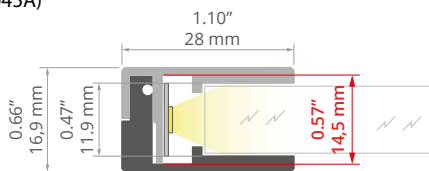

Zaślepki / End caps:  
 C24308C02



### **KRAV-56** (Ref. A18017A)

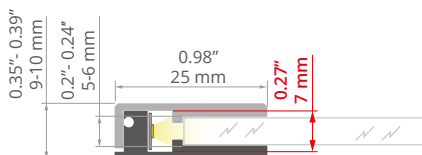

Zaślepki / End caps:  
 C28001C02

### **KRAV-810** (Ref. A18016A)

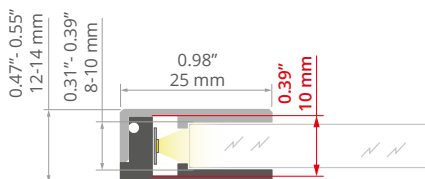

Zaślepki / End caps:  
 C28000C02

**EX-ALU** (Ref. A18043A)



Zaslepki / End caps:  
C24437N00, C24363C10,  
C24363C10TW

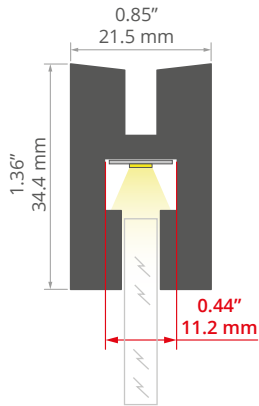



Zastosowania specjalne: podświetlenie schodów  
 Special applications: stair illumination

**STEKO** (Ref. A18018A)

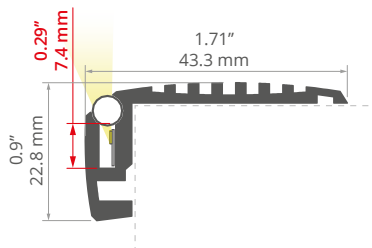

Zaślepki / End caps:  
 C24053C02, C24037C02,  
 C24038C02, C24038C07, C24037C07

**STEP** (Ref. A18042A)

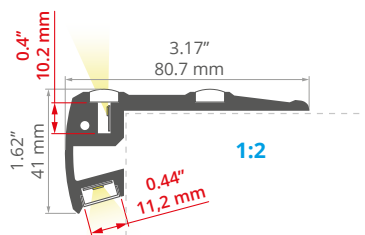

Oslony / Covers  
 mleczne / frosted: B17035M,  
 B17064M, 17075, B17208M,  
 B17121M, B17037M, B17179M  
 przezroczyste / transparent: B17035T,  
 B17208T, B17122T, B17064T  
 czarne / black: B17037C

Zaślepki / End caps:  
 C28006C02, C28007C02,  
 C24025C02, C28007C07, C28006C07

TOP SELLER!

**STEPUS** (Ref. A18038A)

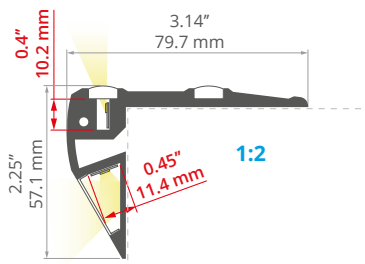

Oslony / Covers  
 mleczne / frosted: B17032M,  
 B17011M  
 mrozone / semi-transparent: B17042F  
 przezroczyste / transparent: B17011T  
 czarne / black: B17032C

Zaślepki / End caps:  
 C28011C02, C28012C02,  
 C28011C07, C28012C07

**POR** (Ref. A06144A)

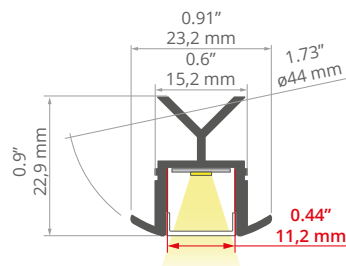

Oslony / Covers  
 mleczne / frosted: B17035M,  
 B17064M, B17208M, B17121M,  
 B17037M, B17179M  
 przezroczyste / transparent: B17035T,  
 B17208T, B17122T, B17064T  
 czarne / black: B17037C

Zaślepki / End caps:  
 C24021C02, C24021C02TW





Zastosowania specjalne: podłogowe  
 Special applications: for floors

**HR-ALU** (Ref. A01889N)

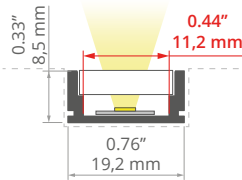

Oslony / Covers  
 mleczne / frosted: 0945

Zaślepki / End caps:  
 C20100C02, C20100C02TW

**HR-MAX** (Ref. A01829A)



**NEW!**

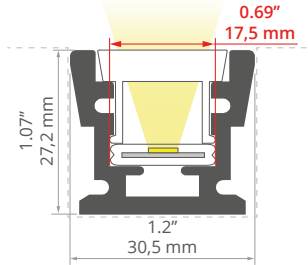

Oslony / Covers  
 mleczne / frosted: B17152M

Zaślepki / End caps:  
 C28020N00





← HR-OPTI



Zastosowania specjalne: fasadowe  
Special applications: facade

**HR-OPTI** (Ref. A01844A)



**NEW!**

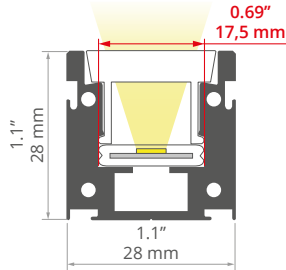

Oslony / Covers  
mleczne / frosted: B17152M

Zaśleпки / End caps:  
C28019N00

**FASKO** (Ref. A04323N)

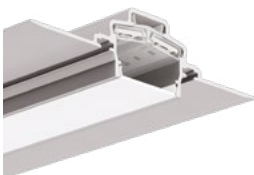

**NEW!**

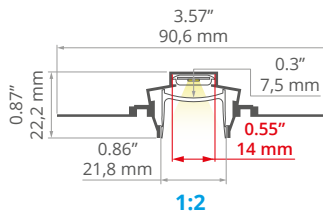

1:2

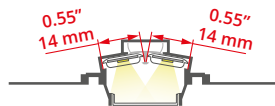

1:2

Oslony / Covers  
mleczne / frosted: B17119M ,  
B17032M, B17011M  
mrożone / semi-transparent: B17042F  
przeźroczyste / transparent: B17011T  
czarne / black: B17032C

Zaśleпки / End caps:  
C24465C02, C24466C02



HR-OPTI

HR-MAX



HR-OPTI

HR-MAX

HR-MAX

TEKNIK-ZM-TK →



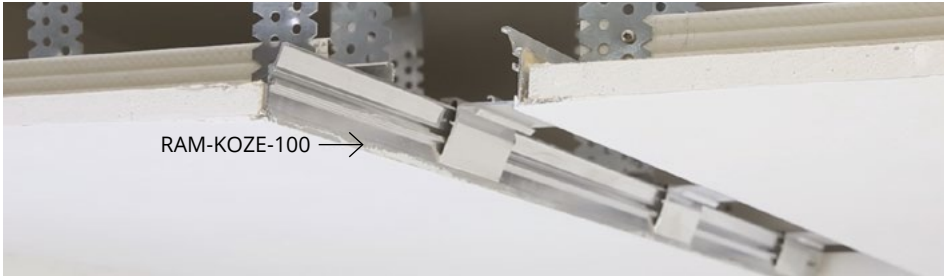

Profile techniczne  
Mounting tracks



**TEKNIK-ZM** (Ref. A00399N)

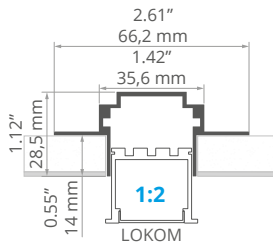
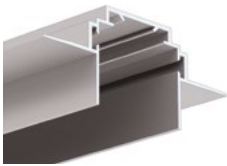

Profile / Profiles:  
A00758A, A05556A, A05554A,  
A05553A

Zaślepki / End caps:  
C24264C02

**TEKUS-ZM** (Ref. A01293N)

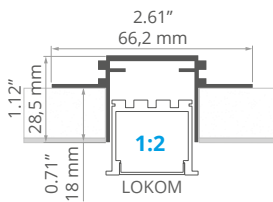
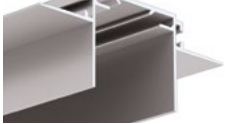

Profile / Profiles:  
A00758A, A05556A, A05554A,  
A05553A

Zaślepki / End caps:  
C24313C02

**TEKUS** (Ref. A06638V1N)

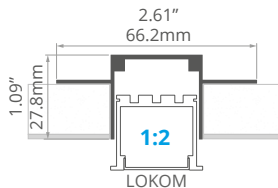
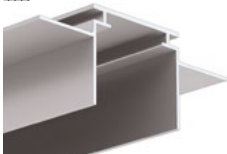

Profile / Profiles:  
A00758A, A05556A, A05554A,  
A05553A

**TEKNIK-ZM-TK** (Ref. A01554N)

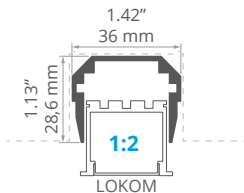
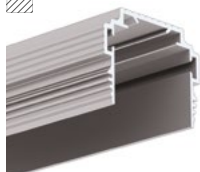

Profile / Profiles:  
A00758A, A05556A, A05554A,  
A05553A

Zašlepki / End caps:  
C24264C02

**TEPIKO** (Ref. A18046N)

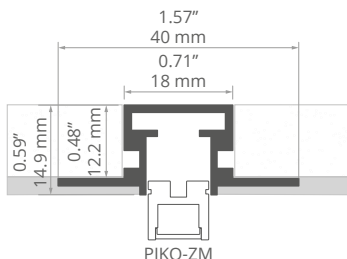

Profile / Profiles:  
A01168A

Zašlepki / End caps:  
C24303C02

**TPK-4** (Ref. A18044N)

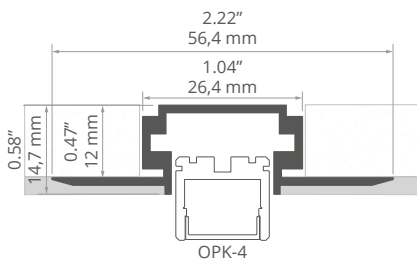
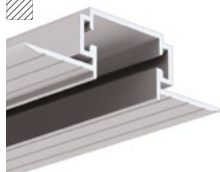

Profile / Profiles:  
A00370A

Zašlepki / End caps:  
C24239C02

**TESE** (Ref. A18021N)

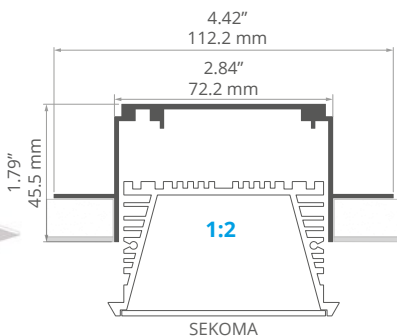
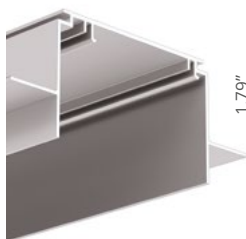

Profile / Profiles:  
A06595A

Zašlepki / End caps:  
C24047C02





**HR-MAX-T** (Ref. A01827N)

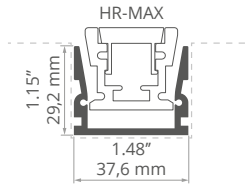

**1:2**

Profile / Profiles:  
A01829A, A01828N

Zašlepki / End caps:  
C28021N00

**HR-MAX-TW** (Ref. A01828N)

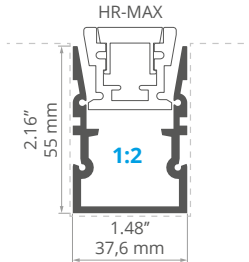

**1:2**

Profile / Profiles:  
A01829A, A01827N

Zašlepki / End caps:  
C28023N00, C28021N00

**RAM-3035-KOZE** (Ref. A18056N)

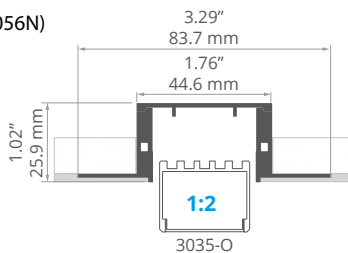

**1:2**

3035-O

Profile / Profiles:  
A08441A

Zašlepki / End caps:  
C24349C02

**RAM-KOZE-50** (Ref. A18055N)

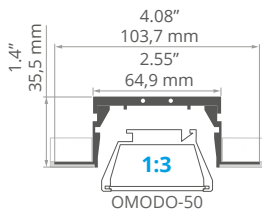

Profile / Profiles:  
A18053A

Zašlepki / End caps:  
C24350C02

**RAM-KOZE-100** (Ref. A18057N)

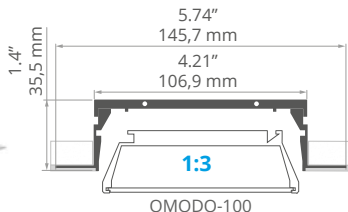

Profile / Profiles:  
A18058A

Zašlepki / End caps:  
C24351C02

**RAM-KOL-50** (Ref. A18060A)

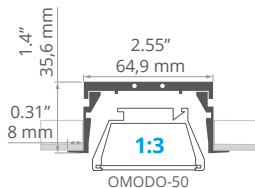

Profile / Profiles:  
A18053A

Zašlepki / End caps:  
C24355C02

**RAM-KOL-100** (Ref. A18062A)

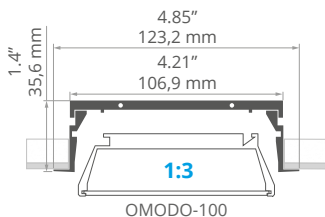

Profile / Profiles:  
A18058A

Zašlepki / End caps:  
C24356C02

**RAM-TEK-50** (Ref. A18059N)

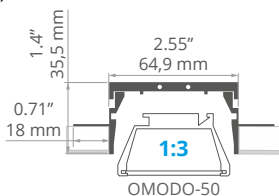

Profile / Profiles:  
A18053A

Zašlepki / End caps:  
C24350C02

**RAM-TEK-100** (Ref. A18061N)

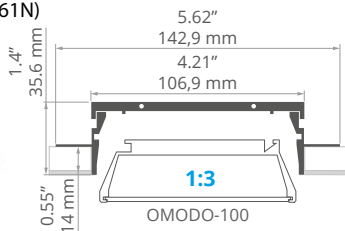

Profile / Profiles:  
A18058A

Zašlepki / End caps:  
C24357C02

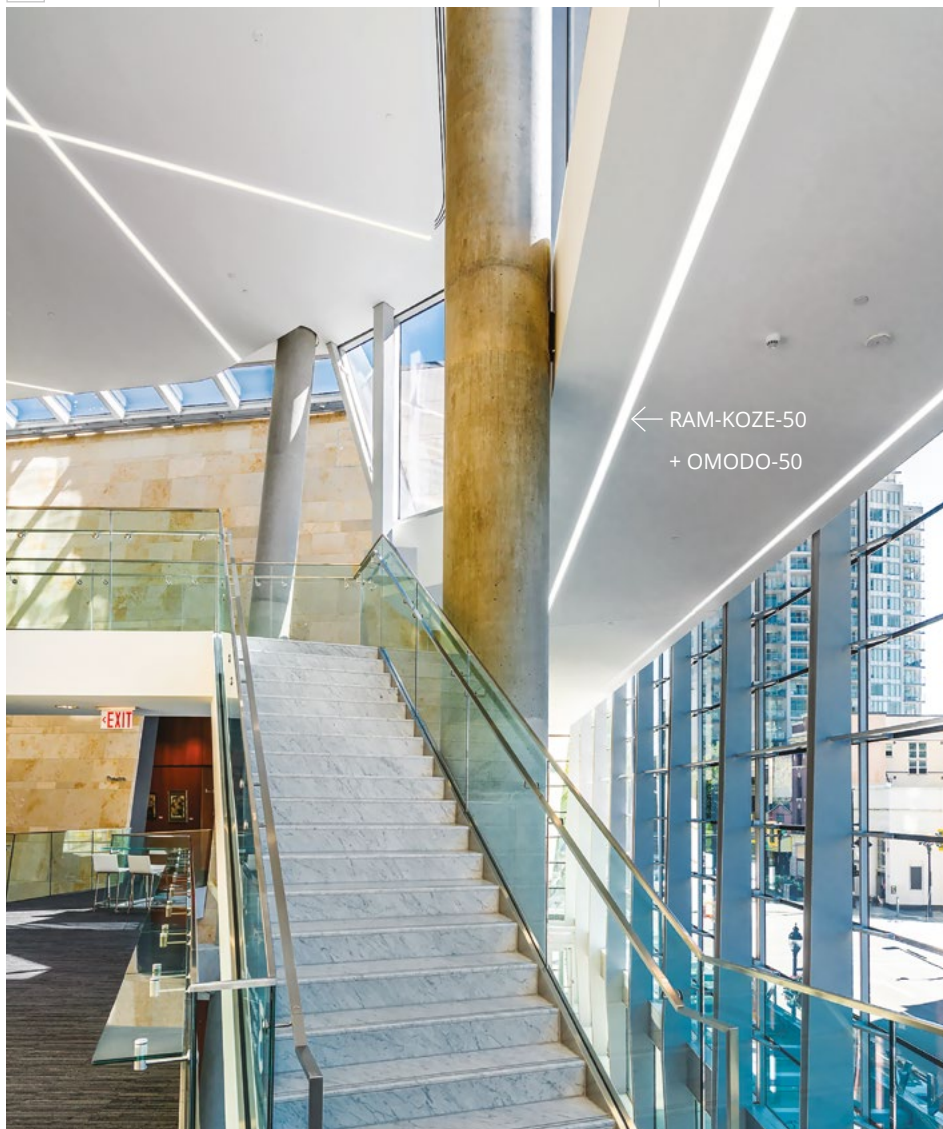

← RAM-KOZE-50  
+ OMODO-50



## Profile techniczne Mounting tracks

### BOX (Ref. A18009A)

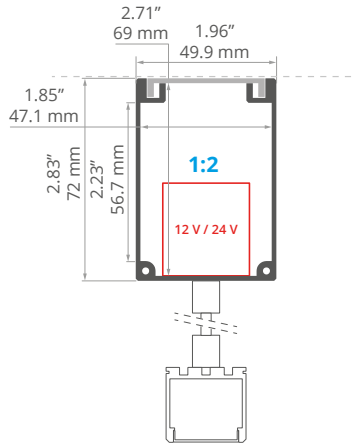

Zaślepki / End caps:  
C20117C02

### NIBO (Ref. A18010A)

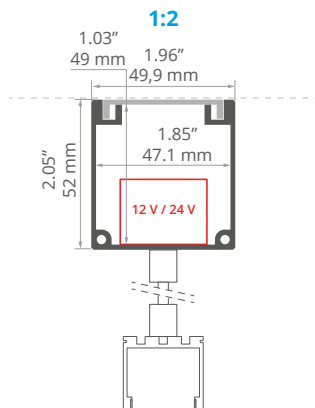
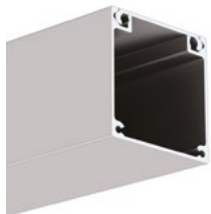

Zaślepki / End caps:  
C24001C02

**TEST-36** (Ref. A06639A)

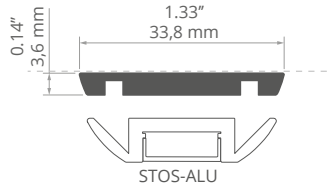

Profile / Profiles:  
A04369A

Zašlepki / End caps:  
C24040L01, C24040C02

**TEST-74** (Ref. A04507A)

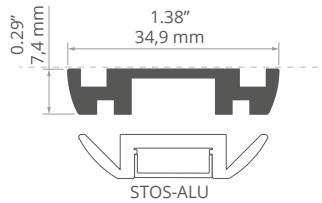

Profile / Profiles:  
A04369A

Zašlepki / End caps:  
C24039L01, C24039C02

**TETRA-43** (Ref. A04478A)

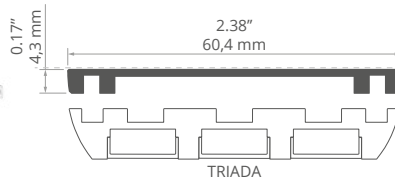

Profile / Profiles:  
A04476A

Zašlepki / End caps:  
C24044L01, C24044C02

**TETRA-78** (Ref. A04508A)

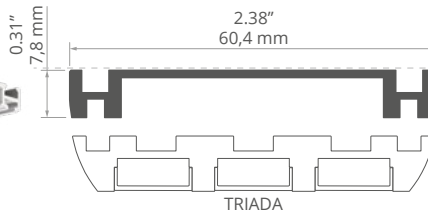

Profile / Profiles:  
A04476A

Zašlepki / End caps:  
C24043L01, C24043C02

**TESPO** (Ref. A18020A)

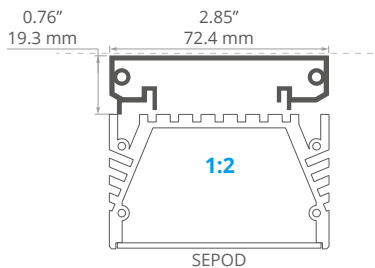

Profile / Profiles:  
A06593A

Zašlepki / End caps:  
C28002L01



POR ↗

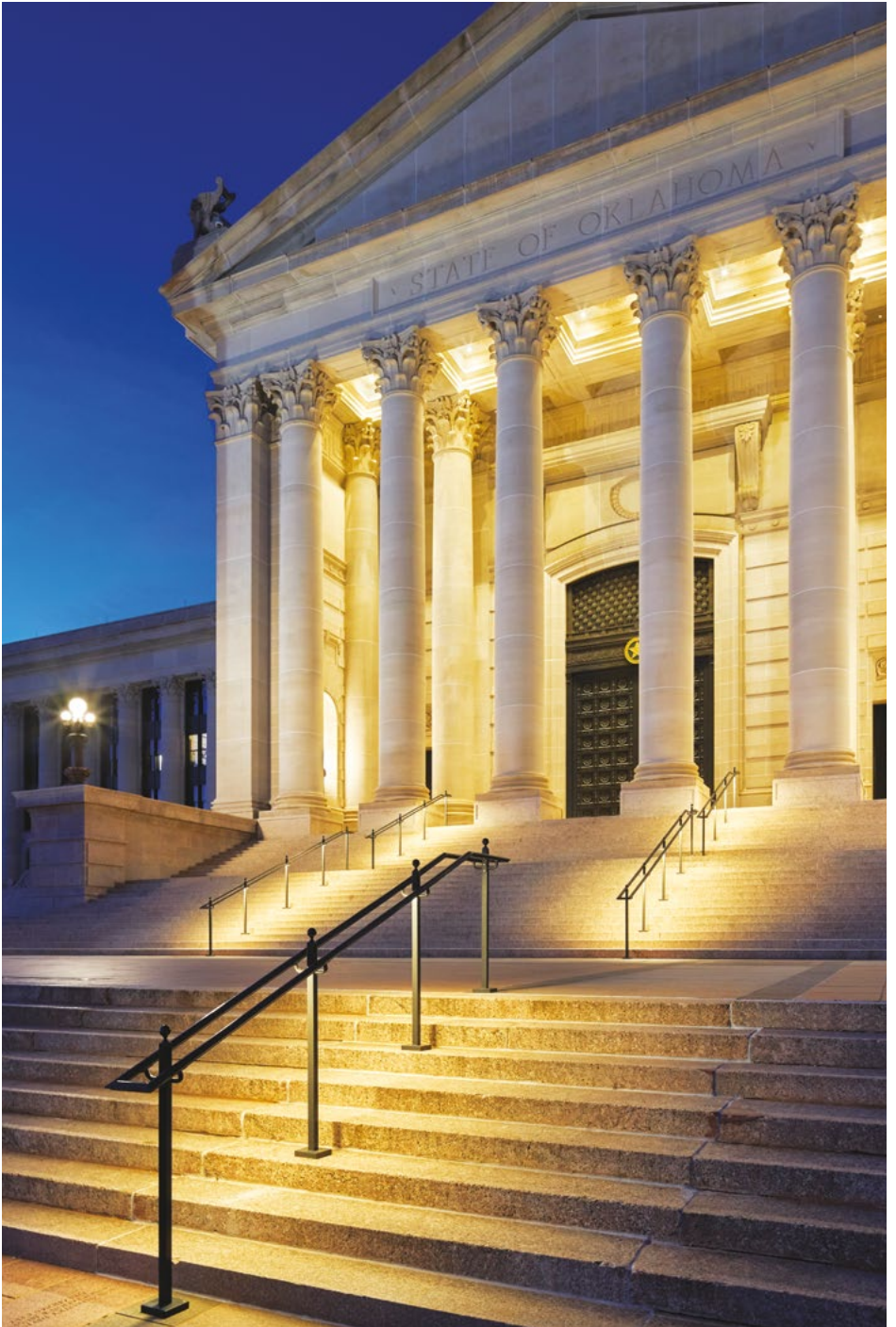

## OSŁONY DO PROFILI COVERS FOR PROFILES

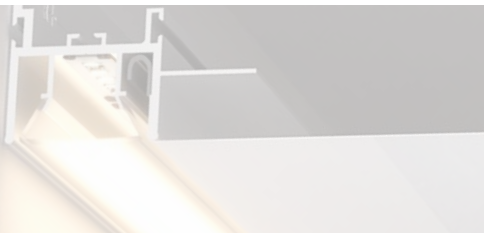

Mleczne / Frosted:



**PIKO**  
(ref. B17034M)

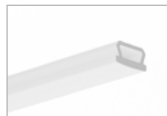

**BENCO-7**  
(ref. B17069M)



**LIGER**  
(ref. B17037M)



**HS**  
(ref. B17208M)



**KA**  
(ref. B17035M)



**KA-COM**  
(ref. B17121M)



**KA-COM**  
(ref. B17179M)



**KA-PRO**  
(ref. B17064M)



**HS-12**  
(ref. B17201M)



**KA-12**  
(ref. B17078M)



**KA-PRO-12**  
(ref. B17066M)



**SILER**  
(ref. B17039M)



**LIGER-22**  
(ref. B17032M)



**HS-22**  
(ref. B17011M)



**3035**  
(ref. B17141M)



**KOPRO-P**  
(ref. B17091M)



**LIGER-50**  
(ref. B17086M)



**T**  
(ref. B17009M)



**POL-40**  
(ref. B17057M)



**HSP-47**  
(ref. B17051M)



**DHS**  
(ref. B17052M)



**POL-50**  
(ref. B17058M)



**SZER**  
(ref. B17081M)



**SZER-L**  
(ref. B17083M)



**SZER-FALA**  
(ref. 17085)



**SZER-STRUKTURA**  
(ref. B17084M)



**POL-100**  
(ref. B17166M)



**LUK-10**  
(ref. B17164M)



**PDS-LUK**  
(ref. B17076M)



**KOPRO-L**  
(ref. B17092M)





**JAZ-DUO**  
(ref. B17163M)



**G-L**  
(ref. B17006M)



**G-L**  
(ref. B17203M)



**JAZ**  
(ref. B17162M)



**FOLED-50**  
(ref. B17171M)

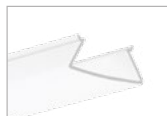

**FOLED**  
(ref. 17077V1)



**FOLED**  
(ref. B17045S)



**M-K**  
(ref. B17038M)



**G-K**  
(ref. 17007)



**G-K**  
(ref. B17013M)



**60**  
(ref. 17075)



**KOPRO-K**  
(ref. B17093M)



**BONI-22**  
(ref. B17119M)



**HR-ALU**  
(ref. 0945)



**HR-LINE**  
(ref. B17207M)



**HR-LINE-2**  
(ref. B17151M)



**HR-21**  
(ref. B17152M)

Czarne / Black:



**LIGER**  
(ref. B17037C)



**LIGER-22**  
(ref. B17032C)



**LIGER-50**  
(ref. B17086C)



**LUK-10**  
(ref. B17064C)



**G-L**  
(ref. B17006C)



**FOLED**  
(ref. B17045C)



**G-K**  
(ref. B17013C)

Mrożone: / Semi-transparent:



MUN-22  
(ref. B17042F)



LUK-10  
(ref. B17064F)



G-L  
(ref.)



G-K  
(ref. B17204F)



KIDES-DUO  
(ref. B17131F)

Przeźroczyste: / Clear:



HS  
(ref. B17208T)



KA  
(ref. B17035T)



KA-COM  
(ref. B17122T)



KA-PRO  
(ref. B17064T)



HS-12  
(ref. B17201T)



KA-12  
(ref. B17078T)



KA-PRO-12  
(ref. B17066T)



SILER  
(ref. B17039T)



HS-22  
(ref. B17011T)



DHS  
(ref. B17052T)



HSP-47  
(ref. B17051T)



SZER  
(ref. B17081T)

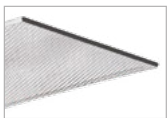

JUN-100  
(ref. 17165\_1.5)



JUN-50  
(ref. 17056\_1.5)



PRS-50  
(ref. B17169T)



JUN-47  
(ref. B17059P)



JUN-40  
(ref. 17055\_1.5)



S  
(ref. B17202T)



S-SATYNA  
(ref. B17202S)



G-L  
(ref. B17006T)



LENSO  
(ref. B17112T)

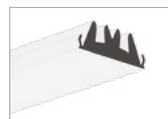

DILENSO  
(ref. B17173)

Dodatkowo, na naszej stronie [www.klusdesign.pl](http://www.klusdesign.pl):

Additionally, on [www.klusdesign.eu](http://www.klusdesign.eu):



Zaślepki do profili / End caps for profiles



Akcesoria do montażu opraw / Accessories for mounting fixtures



Taśmy LED o wysokim standardzie / High-quality LED tapes



Elektronika i komponenty do zasilania opraw LED / Electronics and components for powering LED fixtures



Materiały marketingowe dla partnerów i dystrybutorów / Marketing materials for partners and distributors

PL / EN

**KLUŚ** Sp. z o.o.

Siedziba firmy / Corporate Headquarter  
Słoneczna 126 St,  
05-506 Kolonia Lesznówola, Poland

[www.KlusDesign.pl](http://www.KlusDesign.pl)

[www.KlusDesign.eu](http://www.KlusDesign.eu)

Pytania / Quotes

[info@klus.pl](mailto:info@klus.pl)

Zamówienia / Orders

[orders@klus.pl](mailto:orders@klus.pl)

+48 22 757 40 51

Doradztwo Techniczne / Technical Support

+ 48 22 757 40 51 ext. 28

Firma Klus jest właścicielem patentów swoich rozwiązań na terenie Europy oraz Stanów Zjednoczonych. Uprzejmie informujemy o zastrzeżeniu sobie prawa do zmian asortymentowych i modyfikacji produktów.

Klus products are proprietary and protected under U.S. and foreign patent laws. We reserve the right to change and modify our products.

